

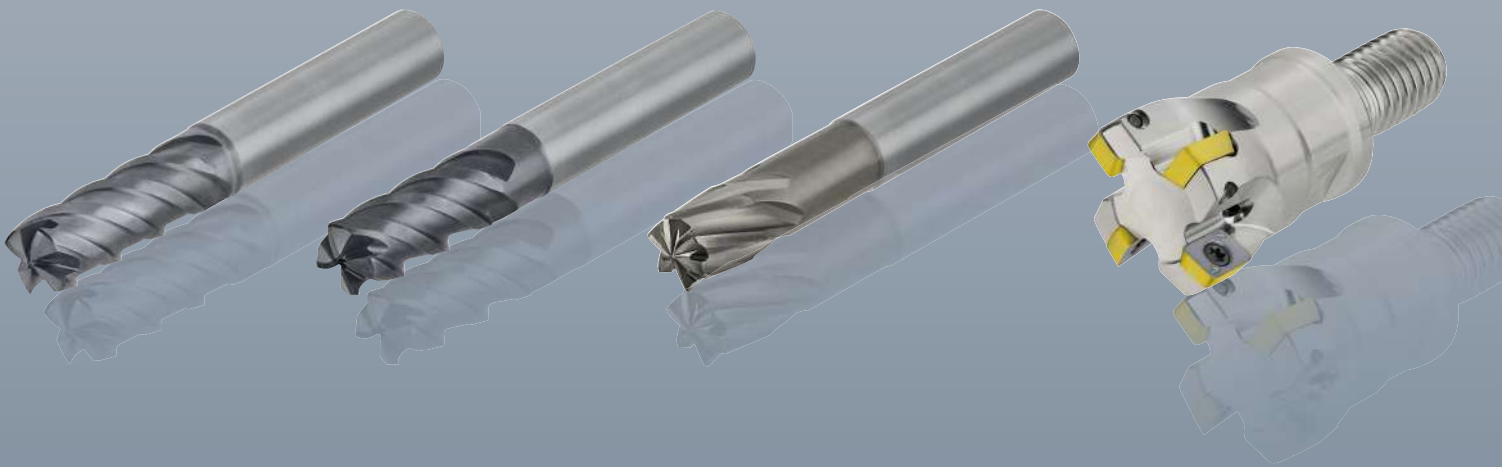

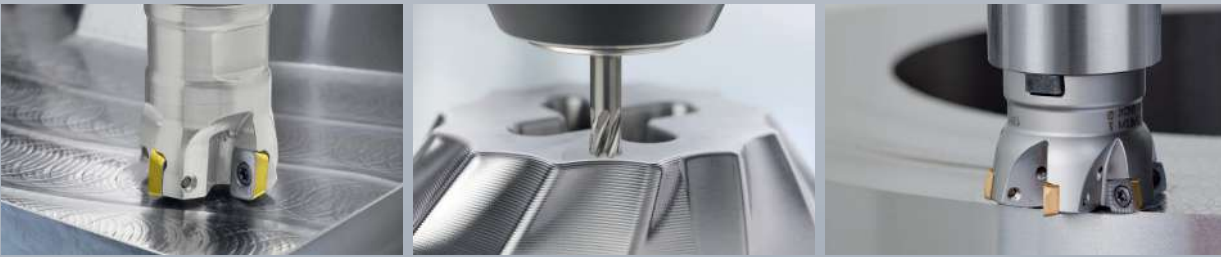









LMT Tools Hochvorschubfräsen LMT Tools High Feed Milling



**Vollhartmetall- und Wendeplattenprogramm
für die Hochvorschubbearbeitung
Solid carbide and indexable insert program
for high feed milling**

Produkt Product	Werkzeugdurchmesser (mm) Tool diameter (mm)
CARBFeed Steel 	1 – 16
CARBFeed Inox 	4 – 16
CARBFeed Hard 	4 – 20
Double 4Feed 	50 – 160
MultiEdge 4Feed 	20 – 100
MultiEdge 2Feed mini 	16 – 80
MultiEdge 3Feed 	16 – 25
WPB...-HF 	6 – 32
Quattro-Jet MFS ¹⁾ 	12 – 20
MultiEdge 4Feed HSC ¹⁾ 	3 – 12
MultiEdge 2Feed HSC ¹⁾ 	1 – 20

¹⁾ Nicht in der Broschüre enthalten – siehe Hauptkatalog „Fräsen Werkzeuge und Wissen“
 Not included in this brochure – see main catalogue “Milling Tools and Knowledge”

Inhaltsübersicht

Contents

-
- 3 **CARBFeed**
Steel, Inox und Hard
Der neue Maßstab des Hochvorschubfräsens
Steel, Inox and Hard
The new benchmark of high feed milling
-
- 16 **MultiEdge 2Feed mini, MultiEdge 3Feed,
MultiEdge 4Feed und MultiEdge Double4Feed**
Hochvorschubfräser mit Wendeplatte
MultiEdge 2Feed mini, MultiEdge 3Feed,
MultiEdge 4Feed and MultiEdge Double4Feed
Indexable high feed milling
-
- 36 **WPB HF**
**Hochvorschub-Wendeplatten für den Gesenk- und
Formenbau**
High feed indexable inserts for mold & die industry

Steigern Sie deutlich Ihre Produktivität und sparen Sie massiv Kosten – mit den Hochvorschubfräsern von LMT Tools. Wir haben unser umfangreiches Programm noch einmal erweitert und bieten Ihnen nun Lösungen für das gesamte Materialspektrum – angefangen bei Guss- und Stahlwerkstoffen über Aluminium und nicht rostende Stähle bis hin zu gehärteten Materialien.

Unsere Vollhartmetall- und Wendeschneidplatten-Werkzeuge für das Hochvorschubfräsen bündeln das technische Know-how und langjährige Erfahrung der LMT Fette und LMT Kieninger. Mit innovativen Schneidstoffen, Beschichtungen und Werkzeuggeometrien erschließen wir kontinuierlich neue Leistungsbereiche.

Hochvorschubfräsen erfolgt mit kleinem Einstellwinkeln (κ). Möglich wird dies durch eine flach angestellte Schneide. Durch die optimierte Spanbildung und die Reduzierung der Schnittkräfte werden die Vorschubwerte deutlich gesteigert.

Ihr Erfolg: kürzere Bearbeitungszeiten, reduzierte Fertigungskosten. Wir beraten Sie gerne über die Möglichkeiten bei Ihrer Anwendung.

Merkmale:

- Leistungsstarke Hochvorschub-Geometrie
- Großes Anwendungsspektrum
- Hohe Präzision und Prozesssicherheit
- Sehr guter Spänetransport
- Leistungsplus durch innovative Beschichtungen und Werkzeuggeometrien

Vorteile:

- Hohes Zeitspanvolumen
- Kürzere Fertigungszeiten
- Hohe Oberflächengüte
- Wirtschaftliche Fertigung

Significantly increase productivity and reduce cost – with the new high feed-rate cutters from LMT Tools. We have extended our wide product range yet again and are now offering solutions for the entire spectrum of materials – from cast iron and steels to aluminum and stainless steels and even hardened materials.

Our solid carbide and indexable insert tools for high feed-rate cutting combine the technical know-how and years of experience from LMT Fette and LMT Kieninger. With our innovative cutting materials, coatings and tool geometries we are continually entering new areas of competence.

High feed-rate cutting occurs using small entering angles (κ). This is made possible by the narrow engaged cutting edge of the tools. Due to the optimized chip forming and the reduction of the radial cutting forces the feed rates can be increased significantly.

For your success: shorter processing times, reduced manufacturing costs. We are looking forward to advise you on possible applications.

Features:

- Powerful high feed-rate geometry
- Wide application spectrum
- High precision and process reliability
- Very good chip transport
- More performance thanks to innovative coatings and tool geometries

Benefits:

- High chip removal rates
- Shorter processing times
- High finish quality
- Economic production

Allgemeine Erklärung Hochvorschub-Geometrie
General description high feed geometry

Eingriffsbedingungen und Spanquerschnitt mit herkömmlicher Rundplatten-Geometrie
Cutting conditions and chip cross section with conventional round-insert geometry

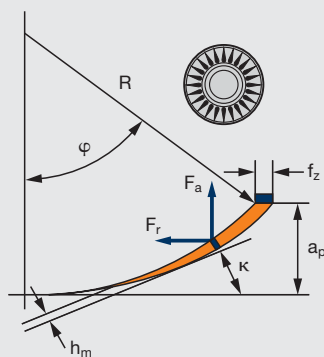

Eingriffsbedingungen und Spanquerschnitt mit Hochvorschub-Geometrie
Cutting conditions and chip cross section with high feed geometry

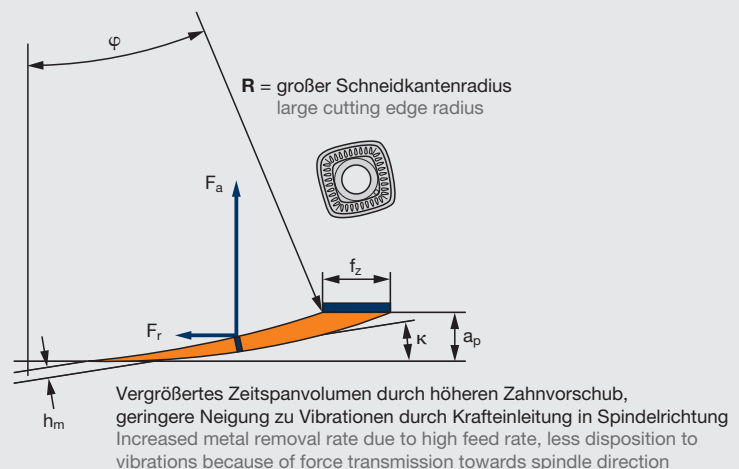

Die neuen Vollhartmetall-Werkzeuge der CARBFeed-Reihe sind mit ihrer Geometrie, Zähnezahl, dem Substrat und den LMT Tools eigenen Beschichtungen bestens auf die Kundenanforderungen abgestimmt. Für jedes Material mit seinen spezifischen Eigenschaften haben wir eine speziell entworfene Geometrie, sodass immer die bestmögliche und effektivste Lösung für den Kunden verfügbar ist.

Die Anwendung:

CARBFeed Steel

- Hauptanwendung ISO-P
- Nebenanwendung ISO-K

CARBFeed Inox

- Hauptanwendung ISO-M
- Nebenanwendung ISO-S

CARBFeed Hard

- Hauptanwendung ISO-H
- Nebenanwendung ISO-K und ISO-P

Einsetzbar im Gesenk- und Formenbau, im allgemeinen Maschinenbau, in der Luft- und Raumfahrt und überall dort, wo das Hochvorschubfräsen zur Anwendung kommt.

Ihre Vorteile:

- Speziell auf die jeweilige Anwendung abgestimmte Geometrie, dadurch immer das richtige Werkzeug für das entsprechende Material
- Neues Substrat und neue Beschichtung für hohe Standzeiten
- Hohe Schneidzahl speziell auch bei der Bearbeitung von gehärteten Materialien. Somit sind extrem hohe Bahnvorschübe möglich, woraus hohe Produktivität resultiert
- Werkzeuge mit Innenkühlung sorgen für hohe Standzeiten bei der Bearbeitung von rostfreien Stählen
- Hohe Vielfalt an unterschiedlichen Längen für eine hohe Varianz an Werkzeugen für vielseitige Anwendungen

The new solid carbide end mills of the CARBFeed series are best suited for the customer's demands with their geometries, number of cutting edges, the substrate and our own LMT Tools coatings. We offer a special geometry for every material with its specific characteristics, therefore the best possible and most efficient solution is always available for the customer.

The application:

CARBFeed Steel

- Main application ISO-P
- Secondary application ISO-K

CARBFeed Inox

- Main application ISO-M
- Secondary application ISO-S

CARBFeed Hard

- Main application ISO-H
- Secondary application ISO-K and ISO-P

Applicable in the mold & die industry, general machining, aerospace and wherever high feed milling is in use.

Your advantages:

- Geometries specially aligned for the applications, therefore always the right tool for the machined material
- New substrate and coating for high tool life
- High number of teeth specially for the machining of hard material, therefore high feed rates are possible, resulting in higher productivity
- Tools with internal cooling provide high tool life when machining stainless steel
- Broad range of different lengths for a higher variety of tools for multiple applications



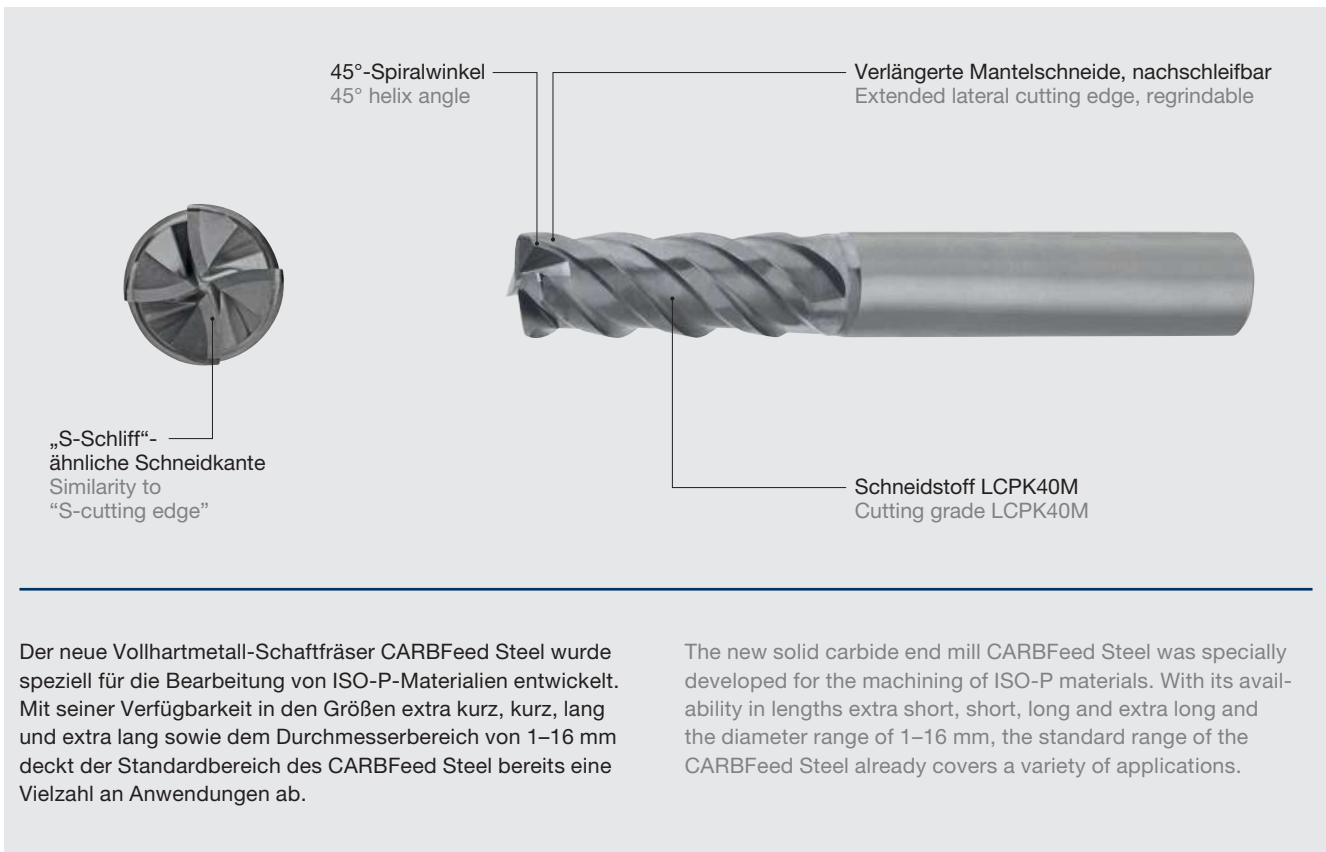

Bearbeitungsbeispiel

Application example

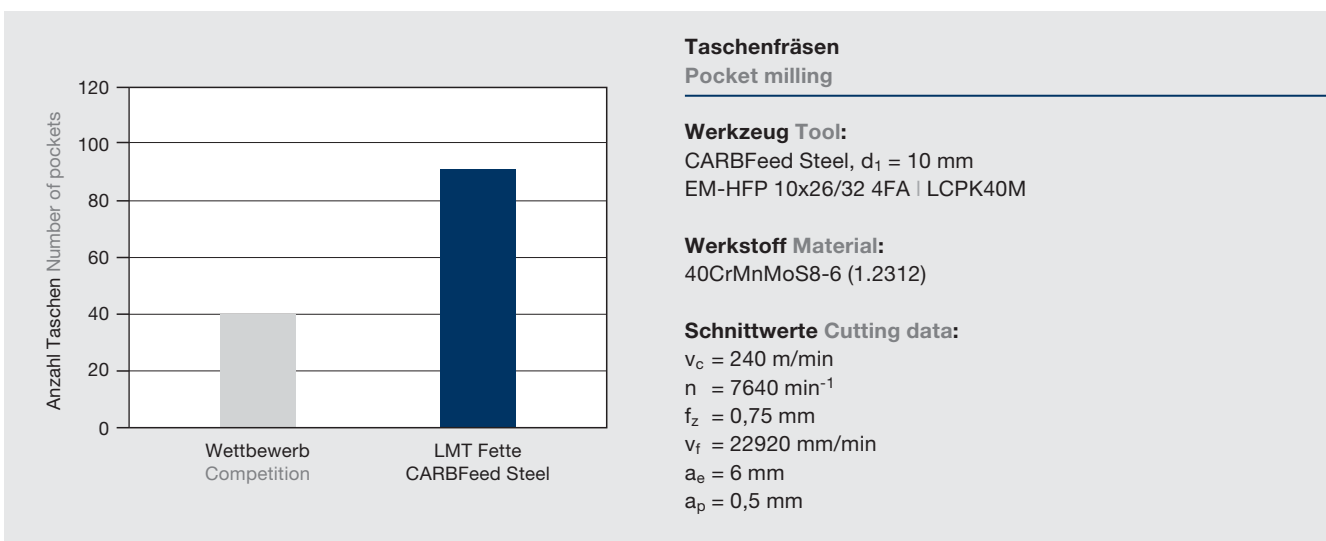

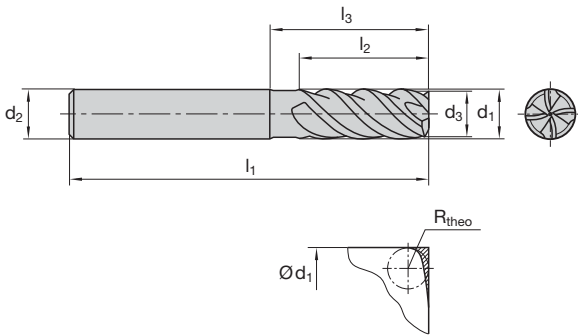

Katalog-Nr. Cat.-No.

1908C

P	■
M	
K	□
N	
S	
H	

d ₁	d ₃	l ₂	l ₁	l ₃	d ₂	z	R _{theo}	a _{p max}	Ident No.	LMT-Code
extra kurz extra short										
2	1,85	3	40	5	4	2	0,2	0,1	7331800	EM-HFP 2x3/5 2FA
3	2,85	4	50	7	6	2	0,3	0,15	7331801	EM-HFP 3x4/7 2FA
4	3,8	5	54	9	6	4	0,4	0,2	7331802	EM-HFP 4x5/9 4FA
5	4,8	6	54	11	6	4	0,5	0,25	7331803	EM-HFP 5x6/11 4FA
6	5,7	7	54	13	6	4	0,6	0,3	7331804	EM-HFP 6x7/13 4FA
8	7,7	9	58	17	8	4	0,8	0,4	7331805	EM-HFP 8x9/17 4FA
10	9,7	11	66	22	10	4	1	0,5	7331806	EM-HFP 10x11/22 4FA
12	11,7	13	73	26	12	4	1,2	0,6	7331807	EM-HFP 12x13/26 4FA
kurz short										
1	0,95	3	38	6	3	2	0,1	0,05	7331808	EM-HFP 1x3/6 2FA
2	1,85	6	40	9	4	2	0,2	0,1	7331809	EM-HFP 2x6/9 2FA
3	2,85	8	54	12	6	2	0,3	0,15	7331810	EM-HFP 3x8/12 2FA
4	3,8	11	57	21	6	4	0,4	0,2	7331811	EM-HFP 4x11/21 4FA
5	4,8	14	57	21	6	4	0,5	0,25	7331812	EM-HFP 5x14/21 4FA
6	5,7	16	57	21	6	4	0,6	0,3	7331813	EM-HFP 6x16/21 4FA
8	7,7	21	63	27	8	4	0,8	0,4	7331814	EM-HFP 8x21/27 4FA
10	9,7	26	72	32	10	4	1	0,5	7331815	EM-HFP 10x26/32 4FA
12	11,7	31	83	38	12	4	1,2	0,6	7331816	EM-HFP 12x31/38 4FA
16	15,7	40	92	44	16	4	1,6	0,8	7331817	EM-HFP 16x40/44 4FA
lang long										
4	3,8	11	70	24	6	4	0,4	0,2	7331818	EM-HFP 4x11/24 4FA
5	4,8	14	70	30	6	4	0,5	0,25	7331819	EM-HFP 5x14/30 4FA
6	5,7	16	80	35	6	4	0,6	0,3	7331820	EM-HFP 6x16/35 4FA
8	7,7	21	80	40	8	4	0,8	0,4	7331821	EM-HFP 8x21/40 4FA
10	9,7	26	90	45	10	4	1	0,5	7331822	EM-HFP 10x26/45 4FA
12	11,7	31	100	50	12	4	1,2	0,6	7331823	EM-HFP 12x31/50 4FA
extra lang extra long										
4	3,8	11	80	40	6	4	0,4	0,2	7331824	EM-HFP 4x11/40 4FA
5	4,8	14	80	42	6	4	0,5	0,25	7331825	EM-HFP 5x14/42 4FA
6	5,7	16	100	64	6	4	0,6	0,3	7331826	EM-HFP 6x16/64 4FA
8	7,7	21	120	84	8	4	0,8	0,4	7331827	EM-HFP 8x21/84 4FA
10	9,7	26	150	110	10	4	1	0,5	7331828	EM-HFP 10x26/110 4FA
12	11,7	31	160	110	12	4	1,2	0,6	7331829	EM-HFP 12x31/110 4FA
16	15,7	40	160	110	16	4	1,6	0,8	7331830	EM-HFP 16x40/110 4FA

Schnittwertempfehlungen ab Seite 6
 Cutting data recommendations starting page 6

■ = Hauptanwendung First choice
 □ = Nebenanwendung Second choice

CARBFeed Steel
Schnittwertempfehlungen
Cutting data recommendations

	Werkstoff	Material	Werkstoff-Nr. Material No.	DIN Bezeichnung Alt DIN Description Old	R_m/UTS (N/mm²)	DIN Bezeichnung Neu DIN Description New
P	Unlegierter Baustahl + Automatenstahl	Plain carbon steel + free cutting steel	1.0570	St52-3	-700	S355J2G3
			1.1730	C45	-800	C45U
			1.0715	9SMn28	-700	11SMn30
			1.1191	Ck45	500-950	C45E
			1.7219	26CrMo4		26CrMo4-2
	Vergütungsstahl, mittelfest	Heat-treatment steel, medium strength	1.7225	42CrMo4	500-950	42CrMo4
			1.8159	51CrV4		51CrV4
	Stahlguss	Cast steel	1.0416	GS40	-950	GS40
	Einsatzstahl	Case hardening steel	1.7131	16MnCr5	-950	16MnCr5
	Rost- und säure- beständiger Stahl, ferritisch, martensitisch	Stainless steel, ferritic, martensitic	1.4006	X10Cr13	500-950	X12Cr13
			1.4104	X12CrMoS17		X14CrMoS17
			1.4122	X35CrMo17		X39CrMo17-1
	Vergütungsstahl, hochfest	Heat-treatment steel, high strength	1.7225	42CrMo4	950-1400	42CrMo4
			1.6580	30CrNiMo8		30CrNiMo8
	Nitrierstahl, vergütet	Nitriding steel, heat treated	1.8504	34CrAl6	950-1400	34CrAl6
			1.2344	X40CrMoV5.1	-900	X40CrMoV5-1
	Werkzeugstahl	Tool steel	1.2343	X38CrMoV5 1	950-1400	X37CrMoV5-1
1.2316			X38CrMo16	-1100	X38CrMo16	
1.2379			X155CrVMo12 1	-950	X153CrMoV12-1	
1.2080			X210Cr12	950-1400	X210Cr12	
1.2358			60CrMoV18-5	850-1000	60CrMoV18-5	
1.2714			55NiCrMoV7	1100-1350	55NiCrMoV7	
1.2311			40CrMnMo7	-1100	40CrMnMo7	
1.2312			40CrMnNiMoS8.6	-1150	40CrMnNiMoS8-6	
1.2738	45CrMnNiMo8.6.4	950-1150	45CrMnNiMo8-6-4			
K	Grauguss	Grey cast iron	0.6025	GG25	100-400 (120-260 HB)	EN-GJI-250
	Legierter Grauguss	Alloyed grey cast iron	0.6678	GGL-NiCr35 2	150-250 (160-230 HB)	EN-GJLA-XNiCr35-2
	Sphäroguss	Nodular cast iron	0.7070	GGG70L	400-800 (120-310 HB)	EN-GJS-700-2U
			0.7060	GGG60		EN-GJS-600-3
	Temperguss	Malleable cast iron	0.8155	GTS55	350-700 (150-280 HB)	EN-GJMB-550-4

Die angegebenen Schnittwerte sind Startwerte und müssen auf die vorhandenen Bedingungen abgestimmt werden.
Bei der langen Ausführung empfehlen wir die f_z-Werte um 30 % zu reduzieren.
The cutting data indicated are starting values and must be adjusted to the prevailing conditions.
We recommended to reduce the f_z-value with the long version by 30 %.

	Schnittgeschwindigkeit Cutting speed v_c (m/min)	Fräserdurchmesser Cutting diameter (mm)				Schnitttiefe Cutting depth a_p (mm)
		Vorschub pro Zahn Feed per tooth f_z (mm/z.)				
		Ø 1-3	Ø 4-6	Ø 8-10	Ø 12-16	
	300	0,30	0,50	0,70	1,00	0,05 x d_1
	300	0,30	0,50	0,70	1,00	
	300	0,30	0,50	0,70	1,00	
	240	0,25	0,40	0,60	0,80	
	200	0,25	0,40	0,60	0,80	
	240	0,25	0,40	0,60	0,80	0,045 x d_1
	200	0,25	0,40	0,60	0,80	
	200	0,25	0,40	0,60	0,80	
	180	0,25	0,40	0,60	0,80	0,04 x d_1
	220	0,25	0,40	0,60	0,80	0,04 x d_1
	200	0,20	0,40	0,50	0,70	
	200	0,25	0,40	0,60	0,80	
	250	0,50	0,70	0,90	1,30	0,04 x d_1
	250	0,45	0,60	0,80	1,20	
	180	0,20	0,30	0,50	0,70	
	180	0,30	0,50	0,70	1,00	
	150	0,30	0,50	0,70	1,00	

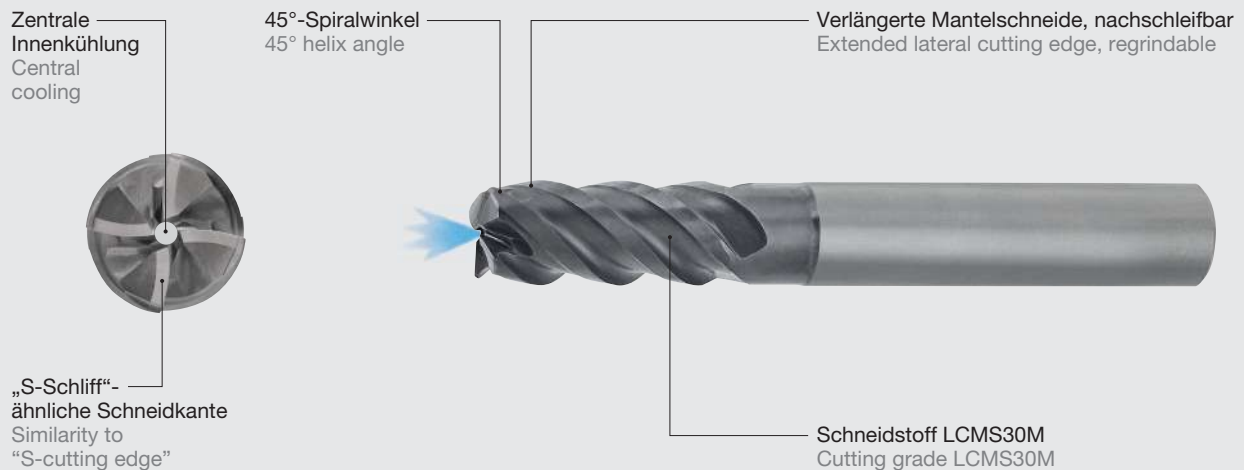

Der neue Vollhartmetall-Schaftfräser CARBFeed Inox wurde speziell für die Bearbeitung von ISO-M-Materialien entwickelt. Der Vierschneider deckt mit seinen Standardlängen extra kurz, kurz, lang und extra lang sowie dem Durchmesserbereich von 4–16 mm bereits ein breites Anwendungsfeld bei rostfreien Stählen, Superlegierungen und Titanbearbeitungen ab. Alle Werkzeuge sind mit innerer Kühlmittelzufuhr ausgelegt.

The new solid carbide end mill CARBFeed Inox was especially developed for the machining of ISO-M materials. The 4-flute end mill already covers a broad range of applications in non-ferrous materials, super alloys and titanium with its standard lengths extra short, short, long and extra long and the diameter range of 4–16 mm. All tools are with internal cooling system.

Bearbeitungsbeispiel Application example

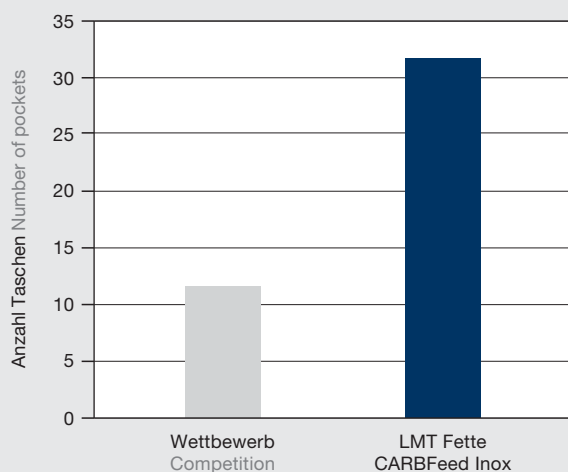

Taschenfräsen Pocket milling

Werkzeug Tool:

CARBFeed Inox, $d_1 = 10$ mm
 EM-HFM10x26/32 4FA-I | LCMS30M

Werkstoff Material:

X6CrNiMoTi17-12-2 (1.4571)

Schnittwerte Cutting data:

$v_c = 230$ m/min
 $n = 7320$ min⁻¹
 $f_z = 0,5$ mm
 $v_f = 7320$ mm/min
 $a_e = 6$ mm
 $a_p = 0,2$ mm

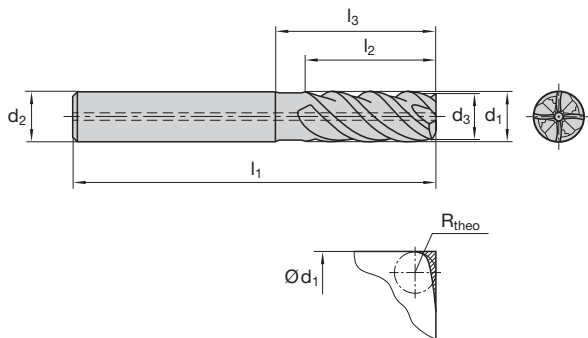

Katalog-Nr. Cat.-No.		1918C									
P											
M		■									
K											
N											
S		□									
H											
d ₁	d ₃	l ₂	l ₁	l ₃	d ₂	z	R _{theo}	a _{p max}	Ident No.	LMT-Code	
extra kurz extra short											
4	3,8	5	54	9	6	4	0,4	0,2	7331855	EM-HFM 4x5/9 4FA-I	
5	4,8	6	54	11	6	4	0,5	0,25	7331856	EM-HFM 5x6/11 4FA-I	
6	5,7	7	54	13	6	4	0,6	0,3	7331857	EM-HFM 6x7/13 4FA-I	
8	7,7	9	58	17	8	4	0,8	0,4	7331858	EM-HFM 8x9/17 4FA-I	
10	9,7	11	66	22	10	4	1	0,5	7331859	EM-HFM 10x11/22 4FA-I	
12	11,7	13	73	26	12	4	1,2	0,6	7331860	EM-HFM 12x13/26 4FA-I	
16	15,7	17	82	34	16	4	1,6	0,8	7331861	EM-HFM 16x17/34 4FA-I	
kurz short											
4	3,8	11	57	16	6	4	0,4	0,2	7331862	EM-HFM 4x11/16 4FA-I	
5	4,8	14	57	18	6	4	0,5	0,25	7331863	EM-HFM 5x14/18 4FA-I	
6	5,7	16	57	21	6	4	0,6	0,3	7331864	EM-HFM 6x16/21 4FA-I	
8	7,7	21	63	27	8	4	0,8	0,4	7331865	EM-HFM 8x21/27 4FA-I	
10	9,7	26	72	32	10	4	1	0,5	7331866	EM-HFM 10x26/32 4FA-I	
12	11,7	31	83	38	12	4	1,2	0,6	7331867	EM-HFM 12x31/38 4FA-I	
16	15,7	40	92	44	16	4	1,6	0,8	7331868	EM-HFM 16x40/44 4FA-I	
lang long											
4	3,8	11	69	24	6	4	0,4	0,2	7331869	EM-HFM 4x11/24 4FA-I	
5	4,8	14	69	26	6	4	0,5	0,25	7331870	EM-HFM 5x14/26 4FA-I	
6	5,7	16	69	33	6	4	0,6	0,3	7331871	EM-HFM 6x16/33 4FA-I	
8	7,7	21	75	39	8	4	0,8	0,4	7331872	EM-HFM 8x21/39 4FA-I	
10	9,7	26	80	40	10	4	1	0,5	7331873	EM-HFM 10x26/40 4FA-I	
12	11,7	31	93	48	12	4	1,2	0,6	7331874	EM-HFM 12x31/48 4FA-I	
16	15,7	40	108	60	16	4	1,6	0,8	7331875	EM-HFM 16x40/60 4FA-I	
extra lang extra long											
4	3,8	11	69	29	6	4	0,4	0,2	7331876	EM-HFM 4x11/29 4FA-I	
5	4,8	14	69	30	6	4	0,5	0,25	7331877	EM-HFM 5x14/30 4FA-I	
6	5,7	16	75	39	6	4	0,6	0,3	7331878	EM-HFM 6x16/39 4FA-I	
8	7,7	21	83	47	8	4	0,8	0,4	7331879	EM-HFM 8x21/47 4FA-I	
10	9,7	26	95	55	10	4	1	0,5	7331880	EM-HFM 10x26/55 4FA-I	
12	11,7	31	110	65	12	4	1,2	0,6	7331881	EM-HFM 12x31/65 4FA-I	
16	15,7	40	125	77	16	4	1,6	0,8	7331882	EM-HFM 16x40/77 4FA-I	

Schnittwertempfehlungen ab Seite 10
 Cutting data recommendations starting page 10

■ = Hauptanwendung First choice
 □ = Nebenanwendung Second choice



CARBFeed Inox
Schnittwertempfehlungen
Cutting data recommendations

	Werkstoff	Material	Werkstoff-Nr. Material No.	DIN Bezeichnung Alt DIN Description Old	R_m/UTS (N/mm²)	DIN Bezeichnung Neu DIN Description New
M	Rost- und säurebeständiger Stahl, austenitisch	Stainless steel, austenitic	1.4301	X2CrNiMo17-12-2	500-950	X5CrNiMo18-10
			1.4404	X6CrNiMoTi17-12-2		X2CrNiMo17-12-2
			1.4571	X10CrNiMoTi18		X10CrNiMoTi18
	Rost- und säurebeständiger Stahl, ferritisch, martensitisch	Stainless steel, ferritic, martensitic	1.2709	X3NiCoMoTi18-9-5	800-1000	X3NiCoMoTi18-9-5
			1.4542	X5CrNiCuNb16-4		X5CrNiCuNb16-4
			1.4568	X7CrNiAl17-7		X7CrNiAl17-7
	Rost- und säurebeständiger Stahl, martensitisch aushärtbar	Stainless steel, martensitic steel	1.2709	X3NiCoMoTi18-9-5	800-1000	X3NiCoMoTi18-9-5
			1.4542	X5CrNiCuNb16-4		X5CrNiCuNb16-4
			1.4568	X7CrNiAl17-7		X7CrNiAl17-7
S	Titan-Legierungen, mittelfest	Titanium alloys, medium strength	3.7164	TiAl6V4	-950	Ti6AlV4
			3.7115	TiAl5Sn2,5		TiAl5Sn2-5
	Titan-Legierungen, hochfest	Titanium alloys, high strength	3.7174	TiAl6Sn2	900-1400	TiAl6V6Sn2
	Nickelbasis-Legierungen, mittelfest	Nickel based alloys, medium strength	2.4670	NiCr12Al6MoNb	-950	NiCr12Al6MoNb
Nickelbasis-Legierungen, hochwarmfest	Heat resistant nickel based alloys, high strength	2.4668	NiCr19Fe19NbMo	900-1400	Inconel 718 NiCr19Fe19Nb5Mo3	

Die angegebenen Schnittwerte sind Startwerte und müssen auf die vorhandenen Bedingungen abgestimmt werden.
The cutting data above are starting values and must be adjusted to the existing conditions.



Nassbearbeitung, auf ausreichende Emulsionszuführung achten
Wet machining requires sufficient emulsion and volume

	Schnitt- geschwindigkeit Cutting speed v_c (m/min)	Kühlung Coolant	Fräserdurchmesser Cutting diameter (mm)			Schnitttiefe Cutting depth a_p (mm)
			Vorschub pro Zahn Feed per tooth f_z (mm/z.)			
			Ø 4-6	Ø 8-10	Ø 12-16	
	180		0,50	0,50	0,70	0,02 x d_1
	180		0,40	0,50	0,70	
	180		0,40	0,50	0,70	
	170		0,40	0,50	0,70	0,02 x d_1
	170		0,40	0,50	0,70	
	140		0,30	0,40	0,50	
	90		0,30	0,40	0,50	
	70		0,30	0,40	0,50	

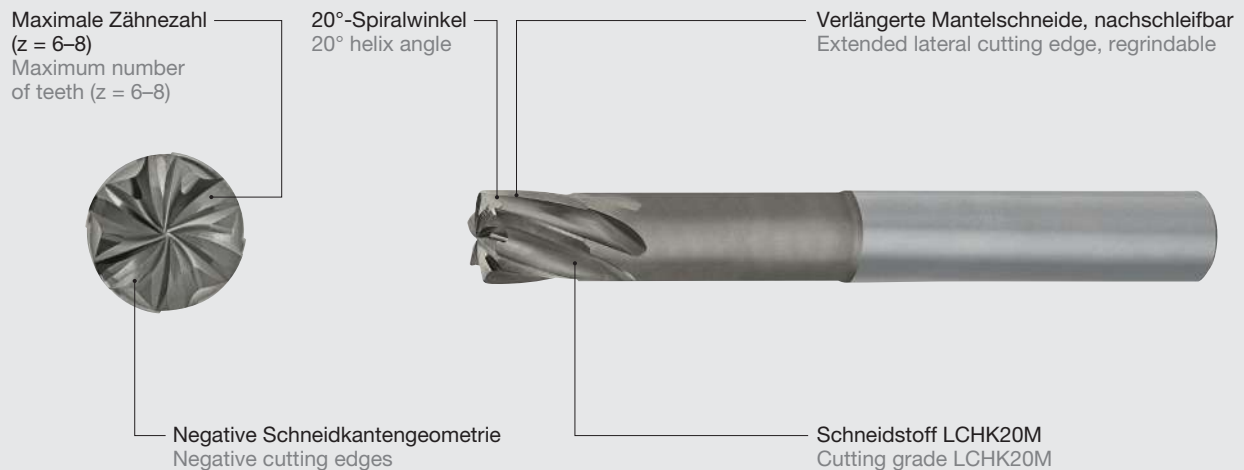

Der neue Vollhartmetall-Schaftfräser CARBFeed Hard wurde speziell für die Bearbeitung von ISO-H-Materialien entwickelt. Der Fräser weist eine maximale Zähnezahl (6–8) auf, die durch die Längen extra kurz, kurz und lang zu einem optimalen Programm ergänzt wird. Der Durchmesserbereich liegt hier bei 4–20 mm.

The new solid carbide end mill CARBFeed Hard was specially developed for the machining of ISO-H materials. The end mill is equipped with a maximum amount of teeth (6–8) that, combined with the lengths extra short, short and long, form an ideal product range. The diameter range for these tools is 4–20 mm.

Bearbeitungsbeispiel

Application example

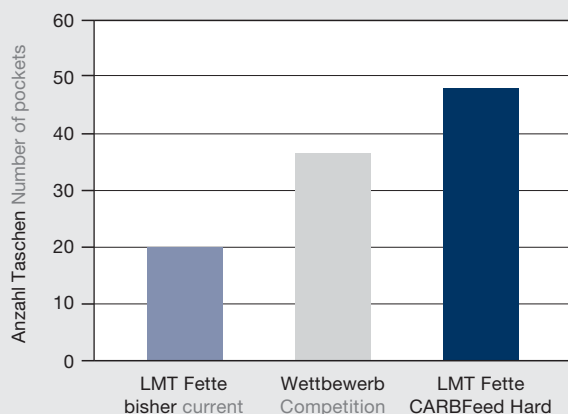

Schruppen Innenkontur

Roughing inner contour

Werkzeug Tool:

CARBFeed Hard, $d_1 = 10$ mm
EM-HFH 10x10/32 6FA | LCHK20M

Werkstoff Material:

X155CrMoV12-1 (1.2379), 60 + 2 HRC

Schnittwerte Cutting data:

$v_c = 100$ m/min
 $n = 3185$ min⁻¹
 $f_z = 0,2$ mm
 $v_f = 2550$ mm/min
 $a_e = 3$ mm
 $a_p = 0,2$ mm

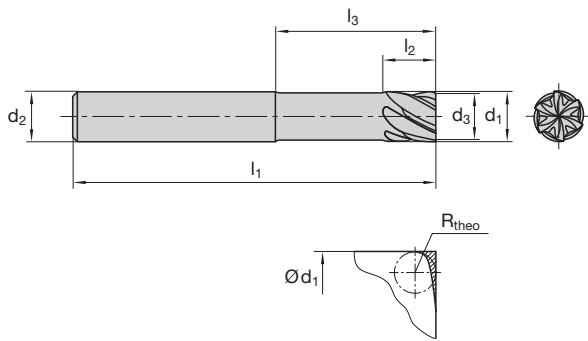

Katalog-Nr. Cat.-No.		1928C									
P		<input type="checkbox"/>									
M											
K		<input type="checkbox"/>									
N											
S											
H		<input checked="" type="checkbox"/>									
d ₁	d ₃	l ₂	l ₁	l ₃	d ₂	z	R _{theo}	a _{p max}	Ident No.	LMT-Code	
extra kurz extra short											
4	3,8	4	57	9	6	6	0,4	0,2	7331831	EM-HFH 4x4/9 6FA	
5	4,8	5	57	11	6	6	0,5	0,25	7331832	EM-HFH 5x5/11 6FA	
6	5,7	6	57	13	6	6	0,6	0,3	7331833	EM-HFH 6x6/13 6FA	
8	7,6	8	63	17	8	6	0,8	0,4	7331834	EM-HFH 8x8/17 6FA	
10	9,5	10	72	22	10	6	1	0,5	7331835	EM-HFH 10x10/22 6FA	
12	11,5	12	83	26	12	6	1,2	0,6	7331836	EM-HFH 12x12/26 6FA	
16	15,5	16	92	34	16	8	1,6	0,8	7331837	EM-HFH 16x16/34 8FA	
20	19,5	20	104	42	20	8	2	1	7331838	EM-HFH 20x20/42 8FA	
kurz short											
4	3,8	4	57	15	6	6	0,4	0,2	7331839	EM-HFH 4x4/15 6FA	
5	4,8	5	57	16	6	6	0,5	0,25	7331840	EM-HFH 5x5/16 6FA	
6	5,7	6	57	19	6	6	0,6	0,3	7331841	EM-HFH 6x6/19 6FA	
8	7,6	8	63	25	8	6	0,8	0,4	7331842	EM-HFH 8x8/25 6FA	
10	9,5	10	72	32	10	6	1	0,5	7331843	EM-HFH 10x10/32 6FA	
12	11,5	12	83	38	12	6	1,2	0,6	7331844	EM-HFH 12x12/38 6FA	
16	15,5	16	100	50	16	8	1,6	0,8	7331845	EM-HFH 16x16/50 8FA	
20	19,5	20	114	62	20	8	2	1	7331846	EM-HFH 20x20/62 8FA	
lang long											
4	3,8	4	70	24	6	6	0,4	0,2	7331847	EM-HFH 4x4/24 6FA	
5	4,8	5	70	30	6	6	0,5	0,25	7331848	EM-HFH 5x5/30 6FA	
6	5,7	6	80	35	6	6	0,6	0,3	7331849	EM-HFH 6x6/35 6FA	
8	7,6	8	80	40	8	6	0,8	0,4	7331850	EM-HFH 8x8/40 6FA	
10	9,5	10	90	45	10	6	1	0,5	7331851	EM-HFH 10x10/45 6FA	
12	11,5	12	100	50	12	6	1,2	0,6	7331852	EM-HFH 12x12/50 6FA	
16	15,5	16	120	66	16	8	1,6	0,8	7331853	EM-HFH 16x16/66 8FA	
20	19,5	20	135	82	20	8	2	1	7331854	EM-HFH 20x20/82 8FA	

Schnittwertempfehlungen ab Seite 14
 Cutting data recommendations starting page 14

■ = Hauptanwendung First choice
 □ = Nebenanwendung Second choice

CARBFeed Hard
Schnittwertempfehlungen
Cutting data recommendations

	Werkstoff	Material	Werkstoff-Nr. Material No.	DIN Bezeichnung Alt DIN Description Old	R_m/UTS (N/mm²)	DIN Bezeichnung Neu DIN Description New
P	Vergütbare Formenstähle	Heat-treatable die steels	1.2311	40CrMnMo7	-1100	40CrMnMo7
			1.2312	40CrMnMoS8.6		40CrMnMoS8-6
			1.2738	40CrMnNiMoS8.6.4		40CrMnNiMoS8-6-4
			1.2711	54NiCrMoV6		54NiCrMoV6
	Durchhärtende Werkzeugstähle	Full hardening tool steels	1.2343	X38CrMoV5 1	350-1400	X37CrMoV5 1
			1.2080	X210Cr12		X210Cr12
			1.2379	X155CrVMo12 1		X153CrVMo12 1
			1.2767	X45NiCrMo4		X45NiCrMo4
	Nitrierstähle	Nitriding steels	1.8550	34CrAlNi7	950-1400	34CrAlNi7
			1.8519	31CrMoV9		31CrMoV9
			1.7735	14CrMoV6.9		14CrMoV6.9
			1.2344	X40CrMoV5.1		X40CrMoV5-1
	K	Grauguss	Grey cast iron	0.6025	GG25	100-400 (120-260 HB)
Legierter Grauguss		Alloyed grey cast iron	0.6678	GGL-NiCr35 2	150-250 (160-230 HB)	EN-GJLA-XNiCr35-2
Sphäroguss		Nodular cast iron	0.7060 0.7070	GGG60 GGG70L	400-800 (120-310 HB)	EN-GJS-600-3 EN-GJS-700-2U
Temperguss		Malleable cast iron	0.8155	GTS55	350-700 (150-280 HB)	EN-GJMB-550-4
H	Gehärteter Stahl	Hardened steel			45-52 HRC	
					53-56 HRC	
					57-62 HRC	
					63-68 HRC	

Die angegebenen Schnittwerte sind Startwerte und müssen auf die vorhandenen Bedingungen abgestimmt werden.
Bei der langen Ausführung empfehlen wir die f_z -Werte um 30 % zu reduzieren.
The cutting data indicated are starting values and must be adjusted to the prevailing conditions.
We recommended to reduce the f_z -value with the long version by 30 %.

	Schnitt- geschwindigkeit Cutting speed v_c (m/min)	Fräserdurchmesser Cutting diameter (mm)						Schnitttiefe Cutting depth a_p (mm) (= $a_{p\ max}$)
		Vorschub pro Zahn Feed per tooth f_z (mm/z.)						
		Ø 4	Ø 5	Ø 6	Ø 8	Ø 10	Ø 12-20	
	240	0,30	0,38	0,45	0,60	0,75	0,90	0,05 x d_1 (= $a_{p\ max}$)
	220	0,30	0,38	0,45	0,60	0,75	0,90	
	200	0,24	0,30	0,36	0,48	0,60	0,70	0,04 x d_1
	200	0,28	0,35	0,42	0,56	0,70	0,85	
	180	0,26	0,33	0,39	0,52	0,65	0,80	0,04 x d_1
	160	0,24	0,30	0,36	0,48	0,60	0,70	
	200	0,28	0,35	0,42	0,56	0,70	0,85	0,04 x d_1
	180	0,26	0,33	0,39	0,52	0,65	0,80	
	160	0,24	0,30	0,36	0,48	0,60	0,70	0,05 x d_1
	200	0,35	0,40	0,55	0,65	0,80	0,95	
	180	0,30	0,35	0,50	0,60	0,75	0,90	
	180	0,30	0,35	0,50	0,60	0,75	0,90	
	160	0,30	0,35	0,50	0,60	0,75	0,90	0,04 x d_1
	160-180	0,16	0,20	0,24	0,32	0,40	0,48	
	120-160	0,12	0,15	0,18	0,24	0,30	0,36	
	100-120	0,08	0,10	0,12	0,16	0,20	0,24	
	80-100	0,06	0,08	0,09	0,12	0,15	0,18	0,01 x d_1

Ausgelegt für Hochvorschubfräsanwendungen bis 1,0 mm ($a_{p \max}$)
Designed for high feed milling applications up to 1.0 mm ($a_{p \max}$)



Unterschiedliche Topografien und Schneidstoffe für die Bearbeitung von Stahl, rostfreiem Stahl, Guss und gehärtetem Stahl
Different topographies and cutting grades for the machining of steel, stainless steel, cast iron and hardened steel

Einheitlich kleine Wendeschneidplatte für den gesamten Durchmesserbereich
Unified small inserts for the entire diameter range



Positive Schnittgeometrie zum Hochvorschubfräsen auch auf leistungsschwachen Bearbeitungszentren
Positive cutting geometry for high feed operations even on less powerful machining centers

Anwendungsbeispiel
Application example



Gesenk- und Formenbau:
3-fache Standzeit bei 10 % kürzeren Bearbeitungszyklen
Mold and die industry:
3 times longer tool life at 10 % shorter machining time

Werkzeug Tool:
 MultiEdge 2Feed mini (Ident No. 7139272)
 $d_1 = 25 \text{ mm}$, $z = 4$
 Wendeplatte Insert: XDMW 090308SR (Ident No. 7139504)

Schneidstoff Cutting material:
 LCP40M

Werkstoff Material:
 SP300

Schnittwerte Cutting data:
 $v_c = 173 \text{ m/min}$ $v_f = 8000 \text{ mm/min}$
 $n = 2200 \text{ min}^{-1}$ $a_e = 17 \text{ mm}$
 $f_z = 0,90 \text{ mm}$ $a_p = 0,4 \text{ mm}$

Ergebnis Result:
 60 Minuten Standzeit (vorher nur 20 Minuten)
 60 minutes tool life (only 20 minutes before)

MultiEdge 2Feed mini
Hochvorschubfräser – Aufschraubausführung
High feed milling cutter – screw-on type

Katalog-Nr. Cat.-No.										EHP IK		
d ₁	d _i	l ₃	d ₃	d ₅	d ₂	z	a _{p max}	Ident No.	LMT-Code			
16	7	28	M8	13	8,5	2	1	7139270	EHP X09.016TR028-I	XDMW 0903... XDMT 0903...	2127640	1048326 T8
16	7	28	M8	13	8,5	3	1	7171528	EHP X09.016TR028-IF			
20	11	30	M10	18	10,5	3	1	7139271	EHP X09.020TS030-I			
20	11	30	M10	18	10,5	4	1	7185986	EHP X09.020TS030-IF			
25	16	33	M12	21	12,5	4	1	7139272	EHP X09.025TF033-I			
32	23	43	M16	29	17	5	1	7139273	EHP X09.032TH043-I			
35	26	43	M16	29	17	5	1	7139274	EHP X09.035TH043-I			
42	33	43	M16	29	17	6	1	7139275	EHP X09.042TH043-I			

MultiEdge 2Feed mini
Hochvorschubfräser – Aufsteckausführung
High feed milling cutter – arbor type

Katalog-Nr. Cat.-No.										FHP IK		
d ₁	d _i	h	d ₅	d ₂	z	a _{p max}	Ident No.	LMT-Code				
35	26	40	32	16	5	1	7143287	FHP X09.035AN-I	XDMW 0903... XDMT 0903...	1044972	1048326 T8	
35	26	40	32	16	6	1	7151696	FHP X09.035AN-IF				
40	31	40	32	16	6	1	7139276	FHP X09.040AN-I				
42	33	40	32	16	6	1	7139277	FHP X09.042AN-I				
50	41	40	40	22	7	1	7139278	FHP X09.050AN-I				
52	43	40	40	22	7	1	7139279	FHP X09.052AN-I				
63	54	50	50	27	8	1	7139280	FHP X09.063AN-I				
66	57	50	50	27	8	1	7139281	FHP X09.066AN-I				
80	71	50	50	27	9	1	7139282	FHP X09.080AN-I				

Schnittwertempfehlungen ab Seite 20
 Cutting data recommendations starting page 20

							Schneidstoffsorten Cutting materials																			
							Ident No.																			
							NEW																			
N = Anzahl der Schneidkanten N = Number of cutting edges	ISO-Code	l	d	s	d ₁	r _{theo}	LCP40M	LCPM40M	LCPK30M	LCP25M	LCPK10M	LCM45M	LCMS34M	LCKP30M	LCKP10M	LCK20M	LCK10M	LCN10M	LWN10M	LCHP15M	LCH50M	Für Fräser For cutter	Cat-No.			
 	XDMW 090308 SR	9	6	3	2,8	1,5	7139504								7139506								EHP IK FHP IK			
	XDMW 090316 SR	9	6	3	2,8	2,0	7154732					7202194 7310100									7258691					
 	XDMT 090308 ER	9	6	3	2,8	1,5	7139507								7139508									EHP IK FHP IK		
	XDMT 090316 ER	9	6	3	2,8	2,0	7154734					7310101														
							■					□			□							□		P		
							□					■	■									□		M		
																■							□		K	
																									N	
													□	■												S
																□							■			H

■ = Hauptanwendung First choice
□ = Nebenanwendung Second choice

Sortenbeschreibung/-bezeichnung siehe Seite 44/45
Description/Designation of grades and ISO-Code see page 44/45

 XDMW	Merkmale: <ul style="list-style-type: none"> Stabile Wendeschneidplatten-Geometrie für die Zerspaltung hochfester Vergütungs- und Werkzeugstähle Negative Schutzfase mit Schneidkantenverrundung 	Features: <ul style="list-style-type: none"> Stable indexable insert geometry for cutting high-strength tempering and tool steels Negative protective chamfer with rounded cutting edge 	Spanformstufen Chip-breaker: - SR
 XDMT	Merkmale: <ul style="list-style-type: none"> Weichschneidende Wendeschneidplatten-Geometrie zur Reduzierung der Zerspankräfte Einsatz bei labilen Aufspannungen Besonders geeignet für Werkzeugmaschinen mit geringerer Antriebsleistung 	Features: <ul style="list-style-type: none"> Soft-cutting indexable insert geometry to reduce cutting forces Use for unstable setups Particularly useful for machine tools with low power capacities 	Spanformstufen Chip-breaker: - ER

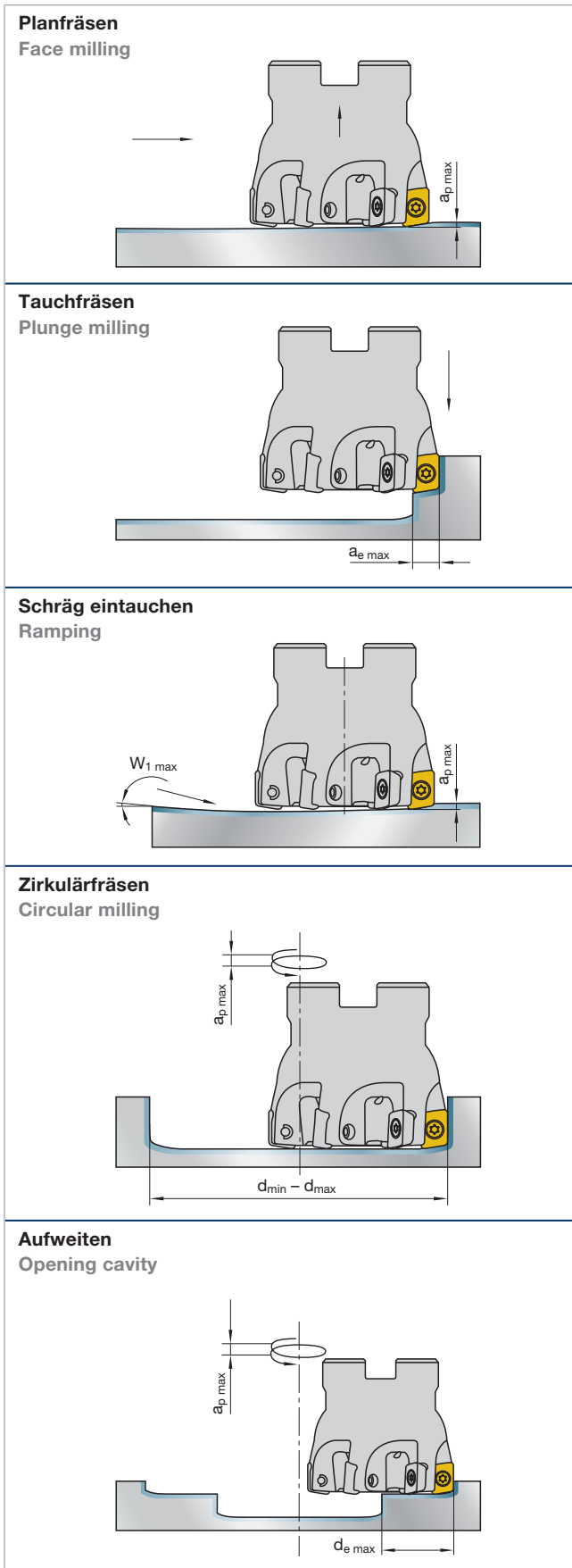

Werkzeug	
Tool	
E(F)HP X09.	
Wendeplatten	XDMW 090308SR
Insert	XDMW 090316SR XDMT 090308ER XDMT 090316ER
$a_p \text{ max (mm)}$	1
$T_{\text{max}} \text{ (mm)}$	0,5
T_{max} : axiale Bohrtiefe axial drilling depth	
$a_e \text{ max (mm)}$	5
$d_1 \text{ (mm)}$	$W_{1 \text{ max}} \text{ (}^\circ\text{)}$
16	4
20	4
25	4
32	2,5
35	2
40/42	1,8
50/52	1,5
63/66	1
80	0,8
$d_1 \text{ (mm)}$	$d_{\text{min}} - d_{\text{max}} \text{ (mm)}$
16	22- 31
20	30- 39
25	40- 49
32	54- 62
35	60- 68
40	70- 78
42	74- 82
50	90- 98
52	94-102
63	116-124
66	122-130
80	150-158
$d_1 \text{ (mm)}$	$d_e \text{ max (mm)}$
16	11
20	15
25	20
32	27
35	30
40	35
42	37
50	45
52	47
63	58
66	61
80	75

MultiEdge 2Feed mini
Schnittwertempfehlungen
Cutting data recommendations

	Werkstoff	Material	Werkstoff-Nr. Material No.	DIN Bezeichnung Alt DIN Description Old	R_m/UTS (N/mm²)	DIN Bezeichnung Neu DIN Description New
P	Unlegierter Baustahl + Automatenstahl	Plain carbon steel + free cutting steel	1.0570	St52-3	-700	S355J2G3
			1.1730	C45	-800	C45U
			1.0715	9SMn28	-700	11SMn30
			1.1191	Ck45	500-950	C45E
			1.7219	26CrMo4	500-950	26CrMo4-2
	Vergütungsstahl, mittelfest	Heat-treatment steel, medium strength	1.7225	42CrMo4	500-950	42CrMo4
			1.8159	51CrV4	500-950	51CrV4
	Stahlguss	Cast steel	1.0416	GS40	-950	GS40
	Einsatzstahl	Case hardening steel	1.7131	16MnCr5	-950	16MnCr5
	Rost- und säure- beständiger Stahl, ferritisch, martensitisch	Stainless steel, ferritic, martensitic	1.4006	X10Cr13	500-950	X12Cr13
			1.4104	X12CrMoS17	500-950	X14CrMoS17
			1.4122	X35CrMo17	500-950	X39CrMo17-1
	Vergütungsstahl, hochfest	Heat-treatment steel, high strength	1.7225	42CrMo4	950-1400	42CrMo4
			1.6580	30CrNiMo8	950-1400	30CrNiMo8
	Nitrierstahl, vergütet	Nitriding steel, heat treated	1.8504	34CrAl6	950-1400	34CrAl6
			1.2344	X40CrMoV5.1	-900	X40CrMoV5-1
	Werkzeugstahl	Tool steel	1.2738	45CrMnNiMo8.6.4	950-1150	45CrMnNiMo8-6-4
1.2379			X155CrVMo12 1	-950	X153CrMoV12-1	
1.2080			X210Cr12	950-1400	X210Cr12	
1.2311			40CrMnMo7	-1100	40CrMnMo7	
1.2312			40CrMnNiMoS8.6	-1150	40CrMnNiMoS8-6	
1.2343			X38CrMoV5 1	950-1400	X37CrMoV5-1	
1.2358			60CrMoV18-5	850-1000	60CrMoV18-5	
1.2714			55NiCrMoV7	1100-1350	55NiCrMoV7	
1.2316	X38CrMo16	-1100	X38CrMo16			
M	Rost- und säure- beständiger Stahl, austenitisch	Stainless steel, austenitic	1.4301	X2CrNiMo17-12-2	500-950	X5CrNiMo18-10
			1.4404	X6CrNiMoTi17-12-2	500-950	X2CrNiMo17-12-2
			1.4571	X10CrNiMoTi18	500-950	X10CrNiMoTi18
	Rost- und säure- beständiger Stahl, martensitisch aushärtbar	Stainless steel, martensitic steel	1.2709	X3NiCoMoTi18-9-5	800-1000	X3NiCoMoTi18-9-5
			1.4542	X5CrNiCuNb16-4	800-1000	X5CrNiCuNb16-4
1.4568	X7CrNiAl17-7	800-1000	X7CrNiAl17-7			
K	Grauguss	Grey cast iron	0.6025	GG25	100-400 (120-260 HB)	EN-GJL-250
	Legierter Grauguss	Alloyed grey cast iron	0.6678	GGL-NiCr35 2	150-250 (160-230 HB)	EN-GJLA-XNiCr35-2
	Sphäroguss	Nodular cast iron	0.7060	GGG60	400-800	EN-GJS-600-3
			0.7070	GGG70L	(120-310 HB)	EN-GJS-700-2U
	Temperguss	Malleable cast iron	0.8155	GTS55	350-700 (150-280 HB)	EN-GJMB-550-4
S	Titan-Legierungen, mittelfest	Titanium alloys, medium strength	3.7115	TiAl5Sn2,5	-950	TiAl5Sn2-5
			3.7164	TiAl6V4	-950	Ti6AlV4
	Titan-Legierungen, hochfest	Titanium alloys, high strength	3.7174	TiAl6Sn2	900-1400	TiAl6V6Sn2
	Nickelbasis-Legierungen, mittelfest	Nickel based alloys, medium strength	2.4670	NiCr12Al6MoNb	-950	NiCr12Al6MoNb
Nickelbasis-Legierungen, hochwarmfest	Heat resistant nickel based alloys, high strength	2.4668	NiCr19Fe19NbMo	900-1400	Inconel 718 NiCr19Fe19Nb5Mo3	
H	Hartguss	Chilled cast iron		Ni-hard, Ampco	300-600 HB	Ni-hard, Ampco
	Gehärteter Stahl	Hardened steel		Sleipner, Toolox	45-52 HRC	Sleipner, Toolox
				Dievar	53-59 HRC	Dievar
				Vandis, Sverker	60-65 HRC	Vandis, Sverker

Die angegebenen Schnittwerte sind Startwerte und müssen auf die vorhandenen Bedingungen abgestimmt werden.
The cutting data indicated are starting values and must be adjusted to the prevailing conditions.

Empfohlene max. Zahnvorschübe f_z in mm bei $a_e = 0,75 \times d_1$ und $a_p = 0,6$ mm
 Recommended max. feed per tooth f_z with $a_e = 0.75 \times d_1$ and $a_p = 0.6$ mm
 (d_1 = Fräserdurchmesser Cutter diameter)

Schnittgeschwindigkeit Cutting speed v_c (m/min)
 Vorschub pro Zahn Feed per tooth f_z (mm/min)

LCP40M			LCM45M LCMS34M			LCKP10M LCHP15M		
v_c	XDMW... f_z	XDMT... f_z	v_c	XDMW... f_z		v_c	XDMW... f_z	XDMT... f_z
200–260	1,70	1,40				260–270	1,50	1,30
160–210	1,50	1,30				180–220	1,40	1,20
150–180	1,40	1,20				160–190	1,30–1,40	1,10–1,20
150–180	1,40	1,20				160–190	1,30–1,40	1,10–1,20
160–210	1,50	1,30				160–210	1,40	1,20
160–210	1,20–1,40	1,00–1,20				160–210	1,20–1,40	1,00–1,20
120–140	1,20	1,00				180	1,00	0,80
160–210	1,00–1,40	0,80–1,20				180–220	1,00–1,40	0,80–1,20
160–210	1,00–1,40	0,80–1,20				180–220	1,00–1,40	0,80–1,20
140–180	1,00–1,40	0,80–1,20				210–240	1,00–1,40	0,80–1,20
140–160		0,60–0,80	200–240	0,60–0,80	0,60–0,80			
120–140		0,60–0,80	200–240	0,60–0,80	0,60–0,80			
						180–200	0,80–1,20	
						200–240	0,80–1,20	
			40–80	0,60–0,80	0,60–0,80			
			20–60	0,60–0,80	0,60–0,80			
			30–80	0,60–0,80	0,60–0,80			
			30–80	0,60–0,80	0,60–0,80			
						60–90	0,70–1,00	
						80	0,70	
						65	0,40	
						60	0,30	

Trockenbearbeitung, Pressluftkühlung ist vorteilhaft
 Dry machining, air-blast cooling is advantageous

Nassbearbeitung, auf ausreichende Emulsionszuführung achten
 Wet machining requires sufficient emulsion and volume

MultiEdge 3Feed
Hochvorschubfräser – Aufschraubausführung
High feed milling cutter – screw-on type

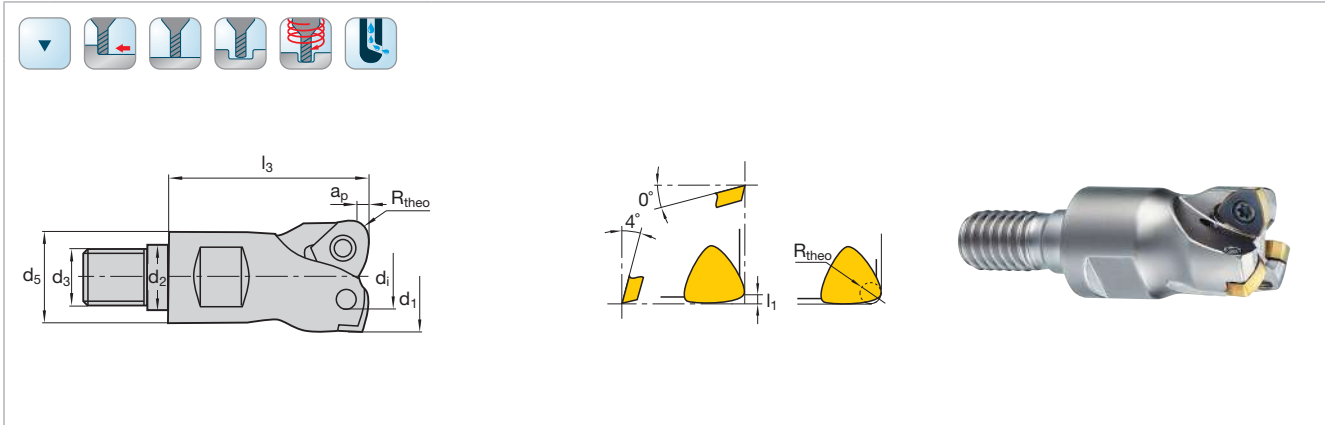

Katalog-Nr. Cat.-No.										ECP IK			
d ₁	d _i	l ₃	d ₃	d ₅	d ₂	z	a _{p max}	R _{theo}	Ident No.	LMT-Code			
16	4,8	28	M8	13	8,5	2	1	1,5	1025001	ECP X07.16TR028-I	XP.. 070308..	1044972	1048326 T8
20	9	30	M10	18	10,5	3	1	1,5	1025005	ECP X07.20TE030-I			
25	14	33	M12	21	12,5	3	1	1,5	1025006	ECP X07.25TF033-I			
25	14	33	M12	21	12,5	4	1	1,5	1025007	ECP X07.25TF033-IF			

Fräser auch verfügbar in Zoll-Abmessungen
 Cutters also available in inch dimensions

MultiEdge 3Feed
Hochvorschubfräser – Schaftausführung
High feed milling cutter – shank type

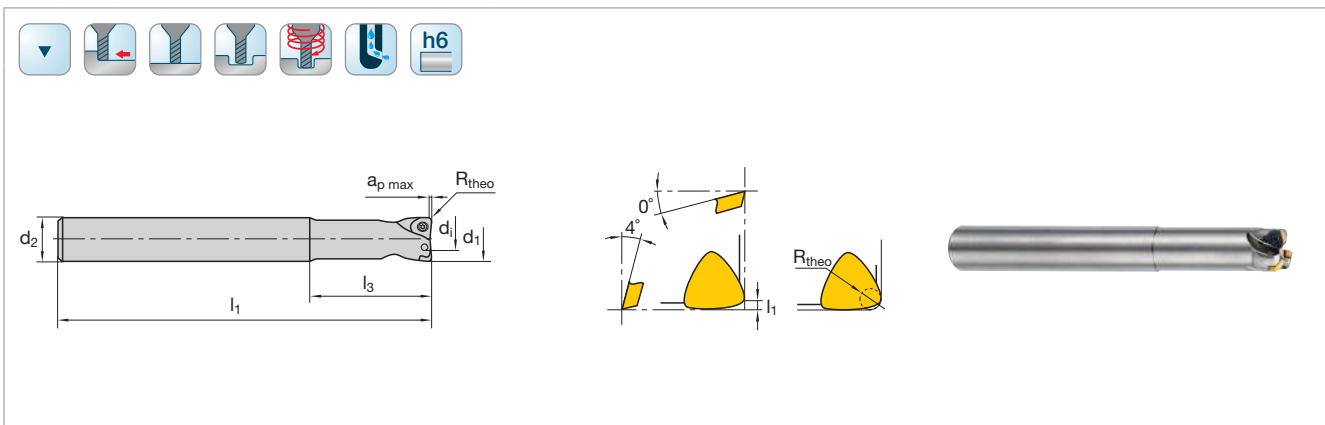

Katalog-Nr. Cat.-No.										ECP IK			
d ₁	d _i	l ₃	l ₁	d ₂	z	a _{p max}	R _{theo}	Ident No.	ISO-Code				
16	4,8	45	160	16	2	1	1,5	1025025	ECP X07.16AN160-I	XP.. 070308..	1044972	1048326 T8	
20	9	60	175	20	3	1	1,5	1025026	ECP X07.20AN175-I				
25	14	75	190	25	3	1	1,5	1025027	ECP X07.25AN190-I				
25	14	75	190	25	4	1	1,5	1025028	ECP X07.25AN190-IF				

Fräser auch verfügbar in Zoll-Abmessungen
 Cutters also available in inch dimensions

Schnittwertempfehlungen ab Seite 24
 Cutting data recommendations starting page 24

		Schneidstoffsorten Cutting materials											Für Fräser For cutter Cat-No.											
		Ident No.																						
N = Anzahl der Schneidkanten N = Number of cutting edges	ISO-Code	l	d	s	d ₁	r	LCP40M	LCPM40M	LCPK30M	LCP25M	LCPK10M	LCM45M		LCM44M	LCKP30M	LCKP10M	LCK20M	LCK10M	LCN10M	LWN10M	LCHP15M	LCH50M		
 N = 3	XPMT 070308 ER	-	6,79	2,78	2,8	0,8	7160176					7160177			7160178								ECP IK	
 N = 3	XPMW 070308 SR	-	6,79	2,78	2,8	0,8	7160173					7160174			7160175									ECP IK
							■				□			□									P	
							□					■												M
															■									K
																								N
															□									S
																								H

■ = Hauptanwendung First choice
 □ = Nebenanwendung Second choice

Sortenbeschreibung/-bezeichnung siehe Seite 44/45
 Description/Designation of grades and ISO-Code see page 44/45

MultiEdge 3Feed
Schnittwertempfehlungen
Cutting data recommendations

	Werkstoff	Material	Werkstoff-Nr. Material No.	DIN Bezeichnung Alt DIN Description Old	R_m/UTS (N/mm²)	DIN Bezeichnung Neu DIN Description New
P	Unlegierter Baustahl + Automatenstahl	Plain carbon steel + free cutting steel	1.0570	St52-3	-700	S355J2G3
			1.1730	C45	-800	C45U
			1.0715	9SMn28	-700	11SMn30
			1.1191 1.7219	Ck45 26CrMo4	500-950	C45E 26CrMo4-2
	Vergütungsstahl, mittelfest	Heat-treatment steel, medium strength	1.7225	42CrMo4	500-950	42CrMo4
			1.8159	51CrV4		51CrV4
	Stahlguss	Cast steel	1.0416	GS40	-950	GS40
	Einsatzstahl	Case hardening steel	1.7131	16MnCr5	-950	16MnCr5
	Rost- und säure- beständiger Stahl, ferritisch, martensitisch	Stainless steel, ferritic, martensitic	1.4006	X10Cr13	500-950	X12Cr13
			1.4104 1.4122	X12CrMoS17 X35CrMo17		X14CrMoS17 X39CrMo17-1
	Vergütungsstahl, hochfest	Heat-treatment steel, high strength	1.7225	42CrMo4	950-1400	42CrMo4
			1.6580	30CrNiMo8		30CrNiMo8
	Nitrierstahl, vergütet	Nitriding steel, heat treated	1.8504	34CrAl6	950-1400	34CrAl6
			1.2344	X40CrMoV5.1	-900	X40CrMoV5-1
	Werkzeugstahl	Tool steel	1.2358	60CrMoV18-5	850-1000	60CrMoV18-5
			1.2714	55NiCrMoV7	1100-1350	55NiCrMoV7
1.2316			X38CrMo16	-1100	X38CrMo16	
1.2343			X38CrMoV5 1	950-1400	X37CrMoV5-1	
1.2311			40CrMnMo7	-1100	40CrMnMo7	
1.2312			40CrMnNiMoS8.6	-1150	40CrMnNiMoS8-6	
1.2738			45CrMnNiMo8.6.4	950-1150	45CrMnNiMo8-6-4	
1.2379 1.2080			X155CrVMo12 1 X210Cr12	-950 950-1400	X153CrMoV12-1 X210Cr12	
M	Rost- und säure- beständiger Stahl, austenitisch	Stainless steel, austenitic	1.4301	X2CrNiMo17-12-2	500-950	X5CrNiMo18-10
			1.4404	X6CrNiMoTi17-12-2		X2CrNiMo17-12-2
			1.4571	X10CrNiMoTi18		X10CrNiMoTi18
	Rost- und säure- beständiger Stahl, martensitisch aushärtbar	Stainless steel, martensitic steel	1.2709	X3NiCoMoTi18-9-5	800-1000	X3NiCoMoTi18-9-5
			1.4542 1.4568	X5CrNiCuNb16-4 X7CrNiAl17-7		X5CrNiCuNb16-4 X7CrNiAl17-7
K	Grauguss	Grey cast iron	0.6025	GG25	100-400 (120-260 HB)	EN-GJL-250
			0.6678	GGL-NiCr35 2	150-250 (160-230 HB)	EN-GJLA-XNiCr35-2
	Sphäroguss	Nodular cast iron	0.7060	GGG60	400-800	EN-GJS-600-3
			0.7070	GGG70L	(120-310 HB)	EN-GJS-700-2U
Temperguss	Malleable cast iron	0.8155	GTS55	350-700 (150-280 HB)	EN-GJMB-550-4	

Die angegebenen Schnittwerte sind Startwerte und müssen auf die vorhandenen Bedingungen abgestimmt werden.
The cutting data indicated are starting values and must be adjusted to the prevailing conditions.



XPMT

Merkmale:

- Weichschneidende Wendeschneidplatten-Geometrie zur Reduzierung der Zerspankräfte
- Einsatz bei labilen Aufspannungen
- Besonders geeignet für Werkzeugmaschinen mit geringerer Antriebsleistung

Features:

- Soft-cutting indexable insert geometry to reduce cutting forces
- Use for unstable setups
- Particularly useful for machine tools with low power capacities

Spanformstufen
Chip-breaker:

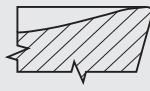

-ER

Vorschub pro Zahn Feed per tooth f_z (mm/z.)					
Schnittgeschwindigkeit Cutting speed v_c (m/min)					
LCP40M		LCM45M		LCKP10M	
v_c	f_z	v_c	f_z	v_c	f_z
200–260	1,70			260–270	1,50
160–200	1,50			180–220	1,40
150–180	1,40			160–190	1,30–1,40
150–180	1,40			160–190	1,30–1,40
140–180	1,50			150–190	1,40
140–180	1,20–1,40			150–190	1,20–1,40
120–140	1,20			180	1,00
140–190	1,00–1,40			210–240	1,00–1,40
		220–260	1,00		
		220–260	1,00		
				200–260	1,70
				160–200	1,40
				200–240	1,00–1,20
				170–210	1,00–1,20

Trockenbearbeitung, Pressluftkühlung ist vorteilhaft
Dry machining, air-blast cooling is advantageous

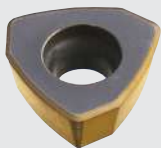

XPHW

Merkmale:

- Stabile Wendeschneidplatten-Geometrie für ein breites Anwendungsspektrum
- Negative Schutzfase mit Schneidkantenverrundung

Features:

- Robust indexable insert geometry for a broad area of application
- Negative protective chamfer with rounded cutting edge

**Spanformstufen
Chip-breaker:**

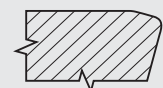

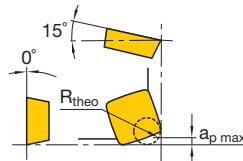
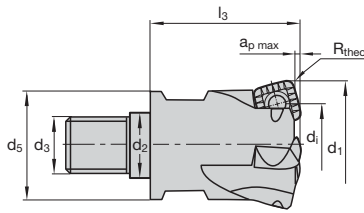

-SR



Katalog-Nr. Cat.-No.										ECP			
d ₁	d _i	l ₃	d ₃	d ₅	d ₂	z	a _{p max}	R _{theo}	Ident No.	LMT-Code			
ECP V07 IK													
20	6,9	30	M10	18	10,5	2	1	1,5	7028485	ECP V07.020TS030-I	XCN.. 070308..	9199156	1048326 T8
25	12	33	M12	21	12,5	3	1	1,5	7028486	ECP V07.025TF033-I			
32	19	43	M16	29	17	3	1	1,5	7028487	ECP V07.032TH043-I			
32	19	43	M16	29	17	4	1	1,5	7028488	ECP V07.032TH043-IF			
35	22	43	M16	29	17	5	1	1,5	7028489	ECP V07.035TH043-I			
ECP V09 IK													
32	17	43	M16	29	17	3	1,2	2,5	7028490	ECP V09.032TH043-I	XCN.. 09T312..	1045105	1048335 T15
32	17	43	M16	29	17	4	1,2	2,5	7028491	ECP V09.032TH043-IF			
35	20	43	M16	29	17	4	1,2	2,5	7028492	ECP V09.035TH043-I			
42	27	43	M16	29	17	4	1,2	2,5	7028493	ECP V09.042TH043-IW			
42	27	43	M16	29	17	5	1,2	2,5	7028494	ECP V09.042TH043-I			

Fräser auch verfügbar in Zoll-Abmessungen
 Cutters also available in inch dimensions

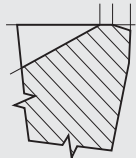
Schnittwertempfehlungen ab Seite 32
 Cutting data recommendations starting page 32

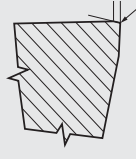
 XCNT	<p>Merkmale:</p> <ul style="list-style-type: none"> ■ Universelle Wendeschneidplatten-Geometrie für ein breites Anwendungsfeld ■ Breite negative Schutzfase für erhöhte Schneidkantenstabilität ■ Optimal für den Einsatz auf leistungsstarken Maschinen 	<p>Features:</p> <ul style="list-style-type: none"> ■ Universal indexable insert geometry for a broad area of application ■ Wide negative protective chamfer for increased cutting edge stability ■ Ideal for use on powerful machines 	<p>Spanformstufen Chip-breakers:</p>  -SN-TR
 XCNW	<p>Merkmale:</p> <ul style="list-style-type: none"> ■ Stabile Wendeschneidplatten-Geometrie für die Zerspanung hochfester Vergütungs- und Werkzeugstähle ■ Negative Schutzfase mit Schneidkantenverrundung 	<p>Features:</p> <ul style="list-style-type: none"> ■ Robust indexable insert geometry for cutting high-strength tempering and tool steels ■ Negative protective chamfer with rounded cutting edge 	<p>Spanformstufen Chip-breakers:</p>  -SN

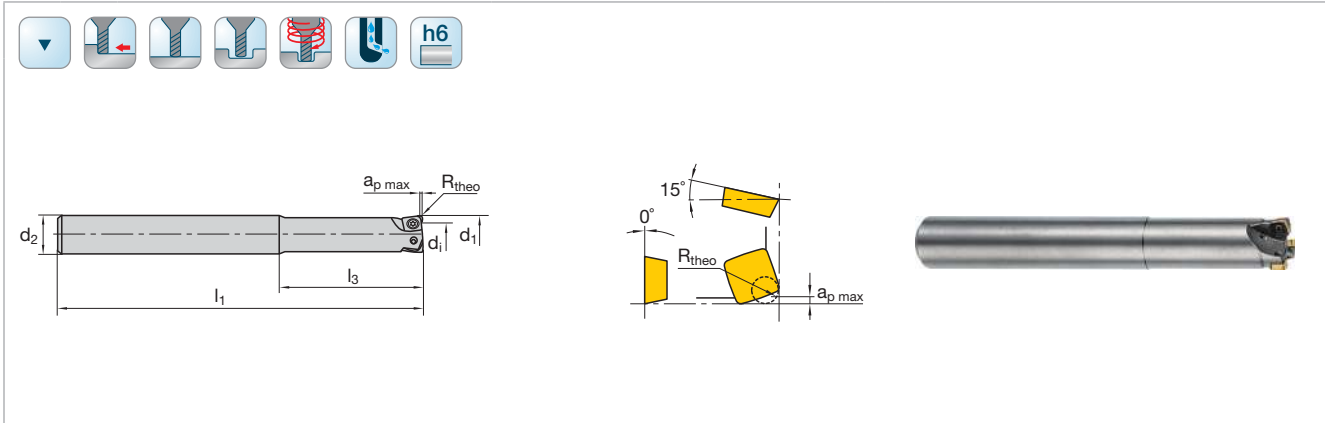

Katalog-Nr. Cat.-No.										ECP			
d ₁	d _i	l ₃	l ₁	d ₂	z	a _{p max}	R _{theo}	Ident No.	LMT-Code				
ECP V07 IK													
20	6,9	60	175	20	2	1	1,5	7028512	ECP V07.020AN175-I	XCN.. 070308..	9199156	1048326 T8	
25	12	75	190	25	3	1	1,5	7028513	ECP V07.025AN190-I				
32	19	80	210	32	3	1	1,5	7028514	ECP V07.032AN210-I				
32	19	80	210	32	4	1	1,5	7028515	ECP V07.032AN210-IF				
ECP V09 IK													
32	17	80	210	32	3	1,2	2,5	7028516	ECP V09.032AN210-I	XCN.. 09T312..	1045105	1048335 T15	
32	17	80	210	32	4	1,2	2,5	7028517	ECP V09.032AN210-IF				

Fräser auch verfügbar in Zoll-Abmessungen
 Cutters also available in inch dimensions

Schnittwertempfehlungen ab Seite 32
 Cutting data recommendations starting page 32

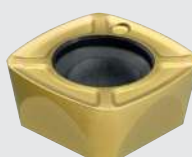
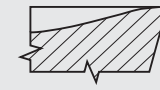
 XCNT	<p>Merkmale:</p> <ul style="list-style-type: none"> ■ Weichschneidende Wendeschneidplatten-Geometrie zur Reduzierung der Zerspankräfte ■ Einsatz bei labilen Aufspannungen ■ Besonders geeignet für Werkzeugmaschinen mit geringerer Antriebsleistung 	<p>Features:</p> <ul style="list-style-type: none"> ■ Soft-cutting indexable insert geometry to reduce cutting forces ■ Use for unstable setups ■ Particularly useful for machine tools with low power capacities 	<p>Spanformstufen Chip-breakers:</p>  -EN
 XCNT	<p>Merkmale:</p> <ul style="list-style-type: none"> ■ Weichschneidende Wendeschneidplatten-Geometrie zur Reduzierung der Zerspankräfte ■ Einsatz rostfreier Stähle und langspanender Werkstoffe ■ Besonders geeignet für Werkzeugmaschinen mit geringerer Antriebsleistung 	<p>Features:</p> <ul style="list-style-type: none"> ■ Soft-cutting indexable insert geometry to reduce cutting forces ■ Use of stainless steels and long-chipping materials ■ Particularly useful for machine tools with low power capacities 	<p>Spanformstufen Chip-breakers:</p>  -EN (-TR)

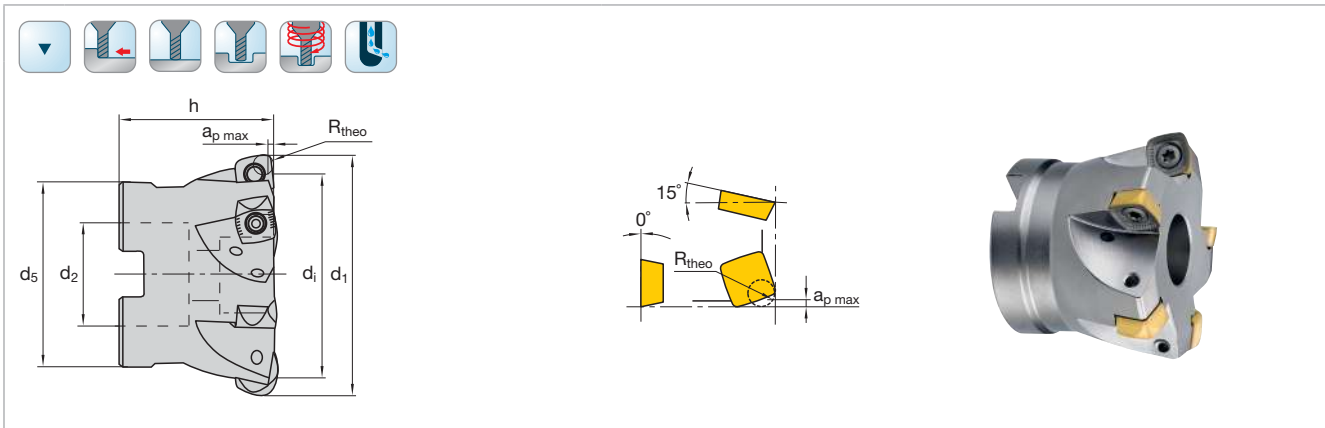

Katalog-Nr. Cat.-No.										FCP					
d ₁	d _i	h	d ₅	d ₂	z	a _{p max}	R _{theo}	Ident No.	LMT-Code						
FCP V09 IK															
42	27	40	32	16	3	1,2	2,5	7028495	FCP V09.042AN-IX				XCN.. 09T312..	1045114	1048335 T15
42	27	40	32	16	4	1,2	2,5	7028496	FCP V09.042AN-IW						
42	27	40	32	16	5	1,2	2,5	7028497	FCP V09.042AN-I						
52	37	40	40	22	4	1,2	2,5	7028498	FCP V09.052AN-IX						
52	37	40	40	22	5	1,2	2,5	7028499	FCP V09.052AN-IW						
52	37	40	40	22	6	1,2	2,5	7028500	FCP V09.052AN-I						
FCP V12 IK															
42	23	40	32	16	3	1,5	3,5	7028501	FCP V12.042AN-IW				XCN.. 120520..	1045123	1048344 T20
42	23	40	32	16	4	1,5	3,5	7028502	FCP V12.042AN-I						
52	33,1	40	40	22	4	1,5	3,5	7028503	FCP V12.052AN-IW						
52	33,1	40	40	22	5	1,5	3,5	7028504	FCP V12.052AN-I						
66	47,1	50	50	27	5	1,5	3,5	7028505	FCP V12.066AN-IX						
66	47,1	50	50	27	6	1,5	3,5	7028506	FCP V12.066AN-IW						
66	47,1	50	50	27	7	1,5	3,5	7028507	FCP V12.066AN-I						
80	61,2	50	60	27	6	1,5	3,5	7028508	FCP V12.080AN-IW						
80	61,2	50	60	27	8	1,5	3,5	7028509	FCP V12.080AN-I						
100	81,2	50	65	32	7	1,5	3,5	7028510	FCP V12.100AN-IW						
100	81,2	50	65	32	10	1,5	3,5	7028511	FCP V12.100AN-I						

Fräser auch verfügbar in Zoll-Abmessungen
 Cutters also available in inch dimensions

Schnittwertempfehlungen ab Seite 32
 Cutting data recommendations starting page 32

N = Anzahl der Schneidkanten N = Number of cutting edges	LMT-Code	l	d	s	d ₁	r	Schneidstoffsorten Cutting materials										Für Fräser For cutter	Cat-No.						
							Ident No.																	
							LCP40M	LCPM40M	LCPK30M	LCP25M	LCPK10M	LCM45M	LCM44M	LCKP30M	LCKP10M	LCK20M			LCK10M	LCN10M	LWN10M	LCHP15M	LCH50M	
 N = 4	XCNT 070308 EN-TR	7,94	7,94	3,18	3,4	0,8		9186375	7011714		9186376			9186377							ECP FCP			
	XCNT 09T312 EN-TR	9,52	9,52	3,97	3,8	1,2		9186350	7011717		9186351			9186352										
	XCNT 120520 EN-TR	12,7	12,7	5,56	5,2	2,0		9186206	7011721		9186207			9186208										
 N = 4	XCNT 070308 SN-TR	7,94	7,94	3,18	3,4	0,8		1058100			1058101			1058106		7047949					ECP FCP			
	XCNT 09T312 SN-TR	9,52	9,52	3,97	3,8	1,2		1058102			1058103			1058107		7047950								
	XCNT 120520 SN-TR	12,7	12,7	5,56	5,2	2,0		1058104			1058105			1058108		7047951								
 N = 4	XCNT 09T312 EN	9,52	9,52	3,97	3,8	1,2		7159747				7159748			7159749							ECP FCP		
	XCNT 120520 EN	12,7	12,7	5,56	5,2	2,0		7159750				7159751												
 N = 4	XCNW 070308 SN	7,94	7,94	3,18	3,4	0,8		9186492			9186493			9186494		7047952						ECP FCP		
	XCNW 09T312 SN	9,52	9,52	3,97	3,8	1,2		9186440			9186441			9186442		7047953								
	XCNW 120520 SN	12,7	12,7	5,56	5,2	2,0		9186431			9186432			9186433		7047954								
■ = Hauptanwendung First choice □ = Nebenanwendung Second choice							■	■	■	■	□	■	□	■	■	■	■	■	■	■	■	■	P	
							□	□	□	□	■	□	□	□	□	□	□	□	□	□	□	□	M	
							□	□	□	□	□	□	□	□	□	□	□	□	□	□	□	□	□	K
							□	□	□	□	□	□	□	□	□	□	□	□	□	□	□	□	□	N
							□	□	□	□	□	□	□	□	□	□	□	□	□	□	□	□	□	S
							□	□	□	□	□	□	□	□	□	□	□	□	□	□	□	□	□	H

Sortenbeschreibung/-bezeichnung siehe Seite 44/45
 Description/Designation of grades and ISO-Code see page 44/45

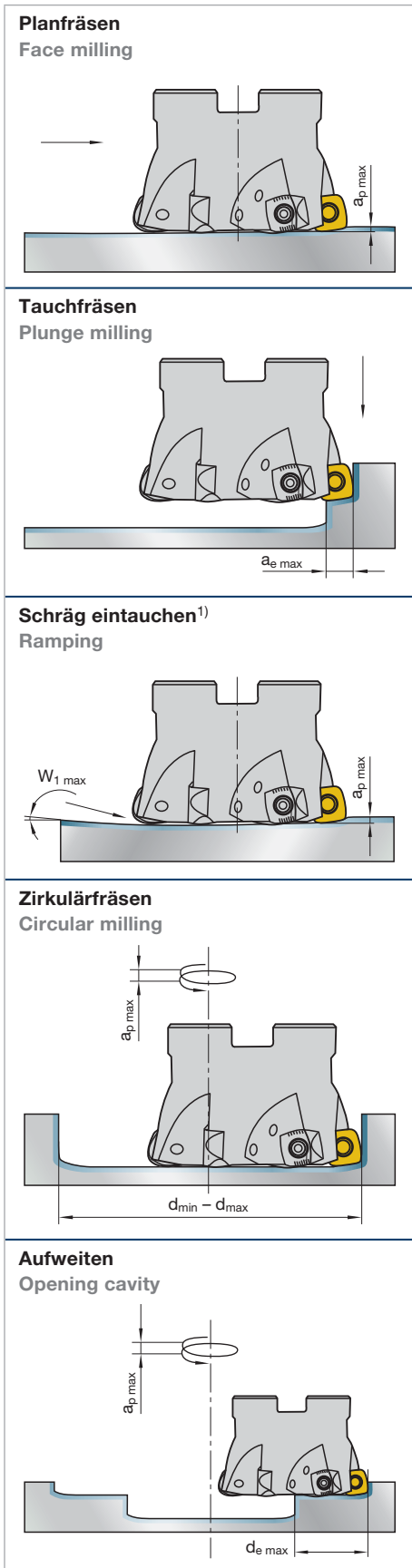

Werkzeug Tool	ECP X07.	ECP V07.	E(F)CP V09.	E(F)CP V12.
Wendeplatten Insert	XPNW070308	XCN_070308	XCN_09T312	XCN_120420
$a_{p \max}$ (mm)	1	0,8	1	1,5
T_{\max} (mm)	0,5	0,8	1	1,5
$a_{e \max}$ (mm)	6	7	8	10
d_1 (mm)	$W_{1 \max}$ (°)			
16	3,5			
20	1,8	7,5		
25	1,2	4		
32		2,5	4	
35		2	3	
42			2	4,5
52			1,5	3
66				2
80				1,5
100				1
d_1 (mm)	$d_{\min} - d_{\max}$ (mm)			
16	20-31			
20	28-39	26-39		
25	38-49	36-49		
32		50-62	48- 62	
35		56-68	54- 68	
42			68- 82	64- 82
52			88-102	84-102
66				112-130
80				140-158
100				180-198
d_1 (mm)	$d_{e \max}$ (mm)			
16	10			
20	14	13		
25	19	18		
32		25	24	
35		28	27	
42			34	32
52			44	42
66				56
80				70
100				90

¹⁾ nicht für Double4Feed Hochvorschub-Planfräsköpfe
not for Double4Feed High feed milling cutters

T_{\max} : axiale Bohrtiefe axial drilling depth



Kopierfräsen, Druckgußform Pumpengehäuse
Copy milling, pump casing pressure die casting mold

Werkzeug Tool:
FCP V12.066 AN-I, $d_1 = 66 \text{ mm}$, $z = 7$

Werkstoff Material:
Werkzeugstahl Tool steel 1.2842
 $R_m = 1000 \text{ N/mm}^2$

Wendeplatte Insert:
XCNW 120520 SN | LCPM40M

Schnittwerte Cutting data:
 $v_c = 220 \text{ m/min}$
 $n = 1060 \text{ min}^{-1}$
 $f_z = 1,8 \text{ mm}$
 $v_f = 13300 \text{ mm/min}$
 $a_e = 45 \text{ mm}$
 $a_p = 1,0 \text{ mm}$

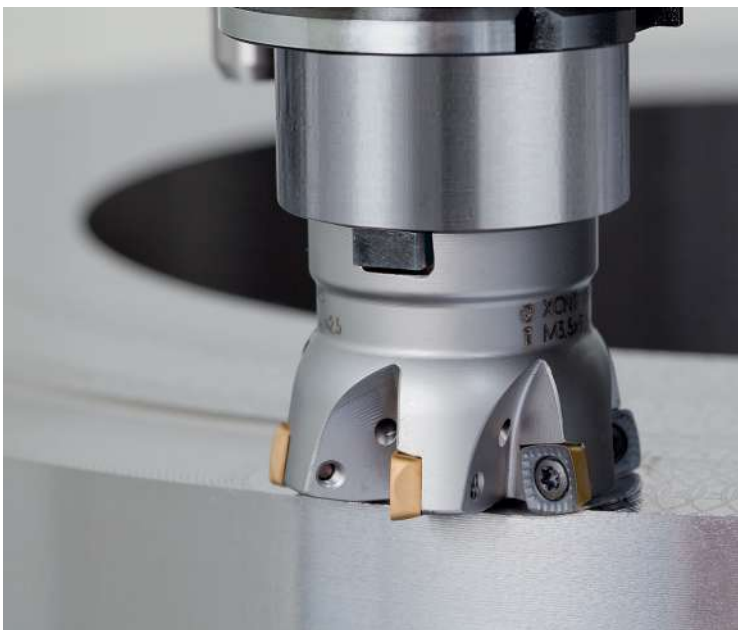

Planfräsen, Maschinenbauteil, Flansch
Face milling, machine component, flange

Werkzeug Tool:
FCP V09.052 AN-I, $d_1 = 52 \text{ mm}$, $z = 6$

Werkstoff Material:
Nichtrostender austenitischer Stahl 1.4301
Stainless steel, austenitic

Wendeplatte Insert:
XCNT 09T312 EN-TR | LCPM40M

Schnittwerte Cutting data:
 $v_c = 240 \text{ m/min}$
 $n = 1470 \text{ min}^{-1}$
 $f_z = 1,2 \text{ mm}$
 $v_f = 10600 \text{ mm/min}$
 $a_e = 35 \text{ mm}$
 $a_p = 1,0 \text{ mm}$

MultiEdge 4Feed
Schnittwertempfehlungen
Cutting data recommendations

				DIN Bezeichnung Alt DIN Description Old	R_m/UTS (N/mm²)	DIN Bezeichnung Neu DIN Description New
	Werkstoff	Material	Werkstoff-Nr. Material No.			
P	Unlegierter Baustahl + Automatenstahl	Plain carbon steel + free cutting steel	1.0570	St52-3	-700	S355J2G3
			1.1730	C45	-800	C45U
			1.0715	9SMn28	-700	11SMn30
			1.1191	Ck45	500-950	C45E
			1.7219	26CrMo4	500-950	26CrMo4-2
	Vergütungsstahl, mittelfest	Heat-treatment steel, medium strength	1.7225	42CrMo4	500-950	42CrMo4
	Stahlguss	Cast steel	1.8159	51CrV4		51CrV4
	Einsatzstahl	Case hardening steel	1.0416	GS40	-950	GS40
	Rost- und säure- beständiger Stahl, ferritisch, martensitisch	Stainless steel, ferritic, martensitic	1.7131	16MnCr5	-950	16MnCr5
			1.4006	X10Cr13	500-950	X12Cr13
			1.4104	X12CrMoS17		X14CrMoS17
	Vergütungsstahl, hochfest	Heat-treatment steel, high strength	1.4122	X35CrMo17		X39CrMo17-1
			1.7225	42CrMo4	950-1400	42CrMo4
			1.6580	30CrNiMo8		30CrNiMo8
	Nitrierstahl, vergütet	Nitriding steel, heat treated	1.2344	X40CrMoV5.1	-900	X40CrMoV5-1
			1.8504	34CrAl6	950-1400	34CrAl6
	Werkzeugstahl	Tool steel	1.2343	X38CrMoV5 1	950-1400	X37CrMoV5-1
1.2379			X155CrVMo12 1	-950	X153CrMoV12-1	
1.2080			X210Cr12	950-1400	X210Cr12	
1.2311			40CrMnMo7	-1100	40CrMnMo7	
1.2312			40CrMnNiMoS8.6	-1150	40CrMnNiMoS8-6	
1.2738			45CrMnNiMo8.6.4	950-1150	45CrMnNiMo8-6-4	
1.2358			60CrMoV18-5	850-1000	60CrMoV18-5	
1.2714			55NiCrMoV7	1100-1350	55NiCrMoV7	
1.2316			X38CrMo16	-1100	X38CrMo16	
M	Rost- und säure- beständiger Stahl, austenitisch	Stainless steel, austenitic	1.4404	X6CrNiMoTi17-12-2	500-950	X2CrNiMo17-12-2
			1.4571	X10CrNiMoTi18		X10CrNiMoTi18
			1.4301	X2CrNiMo17-12-2		X5CrNiMo18-10
Rost- und säure- beständiger Stahl, martensitisch aushärtbar	Stainless steel, martensitic steel	1.2709	X3NiCoMoTi18-9-5	800-1000	X3NiCoMoTi18-9-5	
		1.4542	X5CrNiCuNb16-4		X5CrNiCuNb16-4	
		1.4568	X7CrNiAl17-7		X7CrNiAl17-7	
K	Grauguss	Grey cast iron	0.6025	GG25	100-400 (120-260 HB)	EN-GJ1-250
			0.6678	GGL-NiCr35 2	150-250 (160-230 HB)	EN-GJLA-XNiCr35-2
	Sphäroguss	Nodular cast iron	0.7060	GGG60	400-800 (120-310 HB)	EN-GJS-600-3
			0.7070	GGG70L		EN-GJS-700-2U
Temperguss	Malleable cast iron	0.8155	GTS55	350-700 (150-280 HB)	EN-GJMB-550-4	
N	Aluminium-Legierungen, kurzspanend	Aluminium alloys, short chipping	3.2581	G-AlSi12	-400	G-IGKAISi12
	Aluminium-Legierungen, langspanend	Aluminium alloys, long chipping	3.3535	AlMg3	-550	AlMg3
	Kupfer-Legierungen, kurzspanend	Copper alloys, short chipping	3.4365	AlZnMgCu1,5		AlZnMgCu1,5
	Kupfer-Legierungen, langspanend	Copper alloys, long chipping	2.0402	MS58	-500	CuZn40Pb2
S	Titan-Legierungen, mittelfest	Titanium alloys, medium strength	2.0320	MS63	300-500	CuZn37
			2.0975	CuAl10Ni		CuAl10Fe5Ni5-C
	Titan-Legierungen, hochfest	Titanium alloys, high strength	3.7115	TiAl5Sn2,5	-950	TiAl5Sn2-5
			3.7164	TiAl6V4		TiAl6V4
	Nickelbasis-Legierungen, mittelfest	Titanium alloys, high strength	3.7174	TiAl6Sn2	900-1400	TiAl6V6Sn2
Nickelbasis-Legierungen, hochwarmfest	Nickel based alloys, medium strength	2.4670	NiCr12Al6MoNb	-950	NiCr12Al6MoNb	
Nickelbasis-Legierungen, hochwarmfest	Heat resistant nickel based alloys, high strength	2.4668	NiCr19Fe19NbMo	900-1400	Inconel 718 NiCr19Fe19Nb5Mo3	

Die angegebenen Schnittwerte sind Startwerte und müssen auf die vorhandenen Bedingungen abgestimmt werden.
The cutting data indicated are starting values and must be adjusted to the prevailing conditions.

Empfohlene max. Zahnvorschübe f_z in mm bei $a_e = 0,75 \times d_1$
 Recommended max. feed per tooth f_z with $a_e = 0,75 \times d_1$
 (d_1 = Fräserdurchmesser Cutter diameter)

Schnittgeschwindigkeit Cutting speed v_c (m/min)

LCPM40M LCP40M LCM45M			LCK10M					LCKP10M LCPK10M									
v_c	XCNT07 SN-TR XCNT07 SN	XCNT09 SN-TR XCNT09 SN	XCNT12 SN-TR XCNT12 SN	XCNT07 EN-TR	XCNT09 EN-TR	XCNT12 EN-TR	v_c	XCNT07 SN-TR XCNT07 SN	XCNT09 SN-TR XCNT09 SN	XCNT12 SN-TR XCNT12 SN	v_c	XCNT07 SN-TR TRXCNT07 SN	XCNT09 SN-TR XCNT09 SN	XCNT12 SN-TR XCNT12 SN	XCNT07 EN-TR	XCNT09 EN-TR	XCNT12 EN-TR
200-260	2,00	2,50	3,00	1,40	1,70	2,00					240-300	1,60	2,00	2,40	1,10	1,40	1,60
160-200	1,70	2,00	2,50	1,20	1,50	1,80					180-220	1,40	1,80	2,10	1,00	1,20	1,40
140-180	1,50	1,80	2,20	1,00	1,30	1,60					160-200	1,20	1,60	1,90	0,80	1,00	1,20
140-180	1,50	1,80	2,20	1,00	1,30	1,60					160-200	1,20	1,60	1,90	0,80	1,00	1,20
130-170	1,50	1,80	2,20	1,00	1,30	1,60					140-180	1,20	1,60	1,90	0,80	1,00	1,20
140-180	1,70	2,00	2,50	1,20	1,50	1,80					160-200	1,40	1,80	2,10	1,00	1,20	1,40
120-140	1,60	2,00	2,20	1,10	1,40	1,50					160-200	1,30	1,60	1,80	0,90	1,10	1,20
140-180	1,20-1,80	1,50-2,30	1,80-2,50	0,80-1,30	1,10-1,60	1,30-2,00					180-240	1,00-1,60	1,20-2,00	1,40-2,30	0,70-1,10	0,80-1,40	1,00-1,60
160-220 	0,80	1,20	1,50	0,80	1,20	1,50											
200-260	1,50	2,00	2,50	1,20	1,60	2,00	240-300	1,50	2,00	2,50	200-260	1,50	2,00	2,50	1,20	1,60	2,00
160-200	1,30	1,80	2,20	1,00	1,40	1,80	200-240	1,30	1,80	2,20	180-200	1,30	1,70	2,20	1,00	1,40	1,80
200-240	1,50	2,00	2,50	1,00	1,40	1,70	180-240	1,20	1,40	1,60	200-240	1,50	2,00	2,50	1,00	1,40	1,70
160-200	1,10	1,30	1,50	0,70	0,90	1,00	160-200	1,10	1,30	1,50	160-200	1,10	1,30	1,50	0,70	0,90	1,00
											400-800				1,80	2,00	2,20
											250-400				1,40	1,60	1,80
											80-120				0,50	0,80	1,00
											40-80				0,30	0,50	0,80
											80-120				0,50	0,80	1,00
											40-80				0,30	0,50	0,80

Trockenbearbeitung, Pressluftkühlung ist vorteilhaft
 Dry machining, air-blast cooling is advantageous





	Werkstoff Material	Werkstoff-Nr. Material No.	DIN Bezeichnung DIN Description	R _m /UTS (N/mm ²)	Schnittgeschw. Cutting speed v _c (m/min)	Kühlung Coolant	Empfohlene maximale Zahnvorschübe Recommended max. feed per tooth f _z (mm) bei with a _p = 0,75 x d ₁
							f _z
P	Unlegierter Baustahl Plain carbon steel	1.0037	St 37	300–500	200–240		3,0
		1.0044	St 44				
		1.0038	R St 37-2				
	Automatenstahl Free cutting steel	1.0052	St 52	500–700			2,5
		1.0070	St70				
		1.0711	9 S 20				
	Baustahl Structural alloy steel	1.0715	9 SMn 28	360–550	600–800		
		1.0727	45 S 20				
		1.0728	60 S 20				
	Vergütungsstahl, mittelfest Heat-treatable steel, medium strength	1.1191	C 45E	500–950	140–180		2,5
		1.1221	C 60E				
		1.7219	26 CrMo 4				
	Stahlguss Cast steel	1.7225	42 CrMo 4	200–280 HB	210–250 HB		2,0
		1.7220	GS 34CrMo 4				
		1.2162	21 MnCr5				
	Einsatzstahl Case hardening steel	1.2764	X 19NiCrMo 4	200–280 HB	–850		
1.7131		16 MnCr 5					
1.4003		X 2CrNi 12					
Rost- und säurebeständiger Stahl, ferritisch Stainless steel, ferritic	1.4105	X 4CrMoS 18	280–350 HB	100–140		1,8	
	1.7225	42 CrMo 4					
	1.6580	30 CrNiMo 8					
Nitrierstahl, vergütet Nitriding steel	1.8504	34 CrAl 6	230–300 HB	240–350 HB			
	1.8550	34 CrAlNi 7					
	1.8519	31 CrMoV 9					
Werkzeugstahl Tool steel	1.2080	X 210Cr12	150–280 HB	160–200			
	1.2312	40 CrMnMoS 8.6					
	1.2379	X 155 CrVMo 12 1					
K	Gusseisen mit Lamellengraphit Cast iron with flake graphite	EN-JL-1040 (0.6025)	EN-GJL-250 (GG 25)	120–260 HB	200–260		2,5
		EN-JS-1030 (0.7040)	EN-GJS400 (GGG 40)	135–180 HB	180–240		
	EN-JS-1060 (0.7060)		EN-GJS-600 (GGG 60)	190–270 HB			
	Temperguss Malleable cast iron	EN-JM-1160 (0.8155)	EN-GJMB-550-4 (GTS 55)	150–280 HB	160–200		1,6

Die angegebenen Schnittwerte sind Startwerte und müssen auf die vorhandenen Bedingungen abgestimmt werden.
 The cutting data indicated are starting values and must be adjusted to the prevailing conditions.

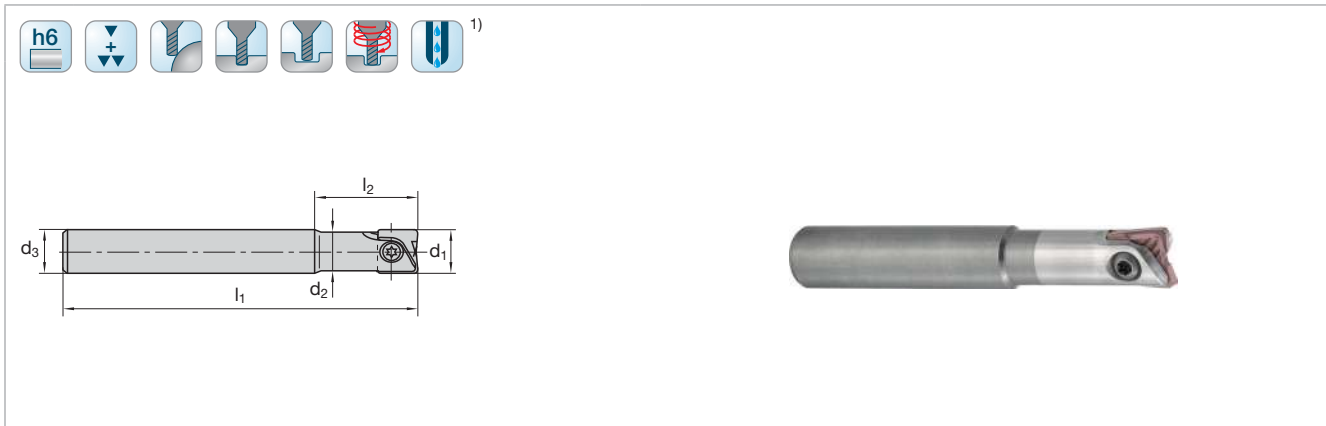
Trockenbearbeitung, Pressluftkühlung ist vorteilhaft
 Dry machining, air-blast cooling is advantageous

Nassbearbeitung, auf ausreichende Emulsionszuführung achten
 Wet machining requires sufficient emulsion and volume



Katalog-Nr. Cat.-No.								GWV				
d ₁	l ₂	l ₁	d ₃	d ₂	z	Ident No.	IKZ ¹⁾ Ident No.	LMT-Code			 ²⁾	
8	27	82	8	7	2	6131510	-	EBG V08.008AN080-C	WPB 08	WPV 08	GWS 08	T8
8	27	102	8	7	2	6130576	-	EBG V08.008AN100-C				
8	42	152	8	7	2	6130577	-	EBG V08.008AN150-C				
10	37	82	10	8,8	2	9074948	6131512	EBG V10.010AN080-C-I	WPB 10	WPV 10	GWS 10	T15
10	37	122	10	8,8	2	6130578	6131511	EBG V10.010AN120-C-I				
10	52	152	10	8,8	2	6130579	6131513	EBG V10.010AN150-C-I				
12	37	82	12	10,5	2	9074949	6131514	EBG V12.012AN080-C-I	WPB 12	WPV 12	GWS 12	T20
12	37	122	12	10,5	2	6128023	6130402	EBG V12.012AN120-C-I				
12	52	162	12	10,5	2	6128030	6130403	EBG V12.012AN160-C-I				
16	42	102	16	14	2	-	6131515	EBG V16.016AN100-C-I	WPB 16	WPV 16	GWS 16	
16	42	142	16	14	2	-	6130404	EBG V16.016AN140-C-I				
16	57	177	16	14	2	-	6130405	EBG V16.016AN175-C-I				
20	52	102	20	18	2	-	6131516	EBG V20.020AN100-C-I	WPB 20	WPV 20	GWS 20	
20	52	142	20	18	2	-	6130406	EBG V20.020AN140-C-I				
20	77	192	20	18	2	-	6130407	EBG V20.020AN190-C-I				
25	62	162	25	22,4	2	6128035	6130408	EBG V25.025AN160-C-I	WPB 25	WPV 25	GWS 25	T30
25	92	212	25	22,4	2	-	6130409	EBG V25.025AN210-C-I				
32	67	192	32	28,6	2	6128040	-	EBG V32.032AN190-C				

¹⁾ IKZ = Innere Kühlmittelzufuhr
 IKZ = Internal coolant supply

²⁾ Anzugsmoment siehe Seite 39
 Torque see page 39





Drehmomentschlüssel auf Anfrage
 Torque spanner on request

Ident No. Schrauben und Torx-Schraubendreher siehe Seite 39
 Ident No. Screws and wrenches see page 39

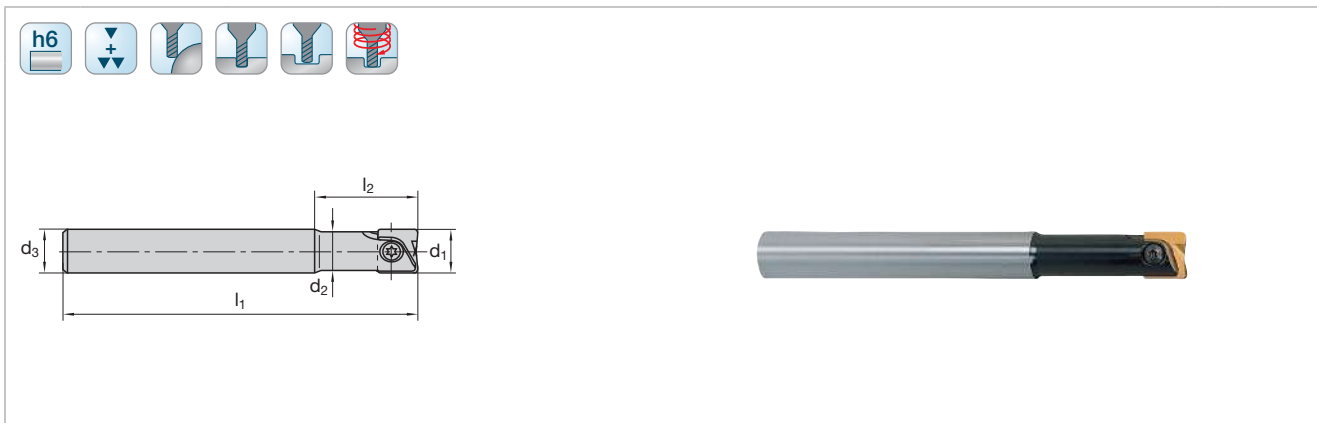
Fräser auch verfügbar in Zoll-Abmessungen
 Cutters also available in inch dimensions

Schnittwertempfehlungen ab Seite 42
 Cutting data recommendations starting page 42



Katalog-Nr. Cat.-No.							GWV				
d ₁	l ₂	l ₁	d ₃	d ₂	z	Ident No.	LMT-Code			 ¹⁾	
12	34	92	12	10,5	2	6130574	EBG V12.012AN090	WPB 12	WPV 12	GWS 12	T20
12	34	132	12	10,5	2	6121399	EBG V12.012AN130				
12	48	152	12	10,5	2	6121383	EBG V12.012AN150				
16	38	102	16	14	2	6130575	EBG V16.016AN100	WPB 16	WPV 16	GWS 16	
16	38	142	16	14	2	6121389	EBG V16.016AN140				
16	55	162	16	14	2	6121391	EBG V16.016AN160				
20	47	162	20	18	2	6121377	EBG V20.020AN160	WPB 20	WPV 20	GWS 20	
20	63	177	20	18	2	6121379	EBG V20.020AN175				
25	47	162	25	22,4	2	6121371	EBG V25.025AN160	WPB 25	WPV 25	GWS 25	T30
25	72	192	25	22,4	2	6121373	EBG V25.025AN190				
32	58	177	32	28,6	2	6121363	EBG V32.032AN175				
32	82	212	32	28,6	2	6121364	EBG V32.032AN210		WPV 32	GWS 32	

¹⁾ Anzugsmoment siehe Seite 39
 Torque see page 39

Schnittwertempfehlungen ab Seite 42
 Cutting data recommendations starting page 42





IKZ auf Anfrage
 Internal cooling on request

Drehmomentschlüssel auf Anfrage
 Torque spanner on request

Ident No. Schrauben und Torx-Schraubendreher siehe Seite 39
 Ident No. Screws and wrenches see page 39

Fräser auch verfügbar in Zoll-Abmessungen
 Cutters also available in inch dimensions



Katalog-Nr. Cat.-No.								GWV					
d ₁	l ₂	l ₁	MK	d ₂	l ₄	z	Ident No.	LMT-Code			 ¹⁾		
12	38	117	2	10,5	53	2	6121321	EBG V12.012M2115	WPB 12	WPV 12	GWS 12	T20	
12	55	132	2	10,5	68	2	6121322	EBG V12.012M2130					
16	38	117	2	15	53	2	6121325	EBG V16.016M2115	WPB 16	WPV 16	GWS 16		
16	55	132	2	14	68	2	6121326	EBG V16.016M2130					
20	47	127	2	17,8	63	2	6121313	EBG V20.020M2125	WPB 20	WPV 20	GWS 20		
20	63	142	2	17,8	78	2	6121314	EBG V20.020M2140	WPB 25	WPV 25	GWS 25	T30	
25	47	147	3	22,4	66	2	6121317	EBG V25.025M3145					
25	72	172	3	22,4	91	2	6121318	EBG V25.025M3170					
32	47	167	4	28,6	64,5	2	6121312	EBG V32.032M4165	WPV 32	GWS 32			
32	72	192	4	28,6	89,5	2	6121302	EBG V32.032M4190					

¹⁾ Anzugsmoment siehe Seite 39
 Torque see page 39

Schnittwertempfehlungen ab Seite 42
 Cutting data recommendations starting page 42

IKZ auf Anfrage
 Internal cooling on request

Drehmomentschlüssel auf Anfrage
 Torque spanner on request

Ident No. Schrauben und Torx-Schraubendreher siehe Seite 39
 Ident No. Screws and wrenches see page 39

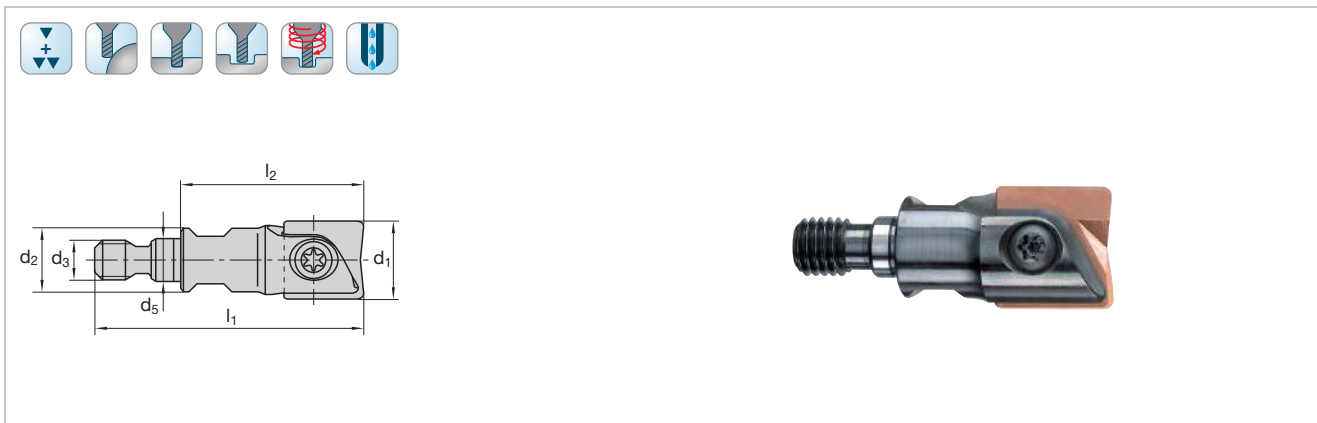

Katalog-Nr. Cat.-No.										GWV				
d ₁	l ₂	l ₁	sw	d ₃	d ₅	d ₂	z	IKZ ¹⁾	Ident No.	LMT-Code				
8	25	39,5	8	M6	6,5	10	2	-	6131472	EBG V08.008TC025	WPB 08	WPV 08	GWS 08	T8
10	25	39,5	8	M6	6,5	10	2	-	6131474	EBG V10.010TC025	WPB 10	WPV 10	GWS 10	T15
12	25	39,5	9	M6	6,5	10	2	-	6131476	EBG V12.012TC025	WPB 12	WPV 12	GWS 12	T20
12	28	45,5	10	M8	8,5	13	2	■	6131478	EBG V12.012TR028-I	WPB 12	WPV 12	GWS 12	
16	28	45,5	10	M8	8,5	13	2	■	6131480	EBG V16.016TR028-I	WPB 16	WPV 16	GWS 16	
20	32	51,5	15	M10	10,5	18	2	■	6131482	EBG V20.020TS032-I	WPB 20	WPV 20	GWS 20	
25	42	64	17	M12	12,5	21	2	■	6131484	EBG V25.025TF042-I	WPB 25	WPV 25	GWS 25	T30
32	47	71	26	M16	17	30	2	■	6131486	EBG V32.032TH047-I		WPV 32	GWS 32	

¹⁾ mit IKZ = Innere Kühlmittelzufuhr
 with IKZ = Internal coolant supply

²⁾ Anzugsmoment siehe Seite 39
 Torque see page 39

Drehmomentschlüssel auf Anfrage
 Torque spanner on request

Ident No. Schrauben und Torx-Schraubendreher siehe Seite 39
 Ident No. Screws and wrenches see page 39

Fräser auch verfügbar in Zoll-Abmessungen
 Cutters also available in inch dimensions

Schnittwertempfehlungen ab Seite 42
 Cutting data recommendations starting page 42

Schrauben und Torx-Schraubendreher Screws and Wrenches

LMT-Code	Ident No.	LMT-Code	Ident No.
GWS 06	6260409	T6	6119544
GWS 08	6119572	T8	6119528
GWS 10	6119571	T15	6119529
GWS 12	6119559	T20	6119530
GWS 16	6119560		
GWS 20	6119561		
GWS 25	6119562		
GWS 32	6119563	T30	6119533



Schnittwertempfehlungen für Wechselplatte WPB-HF Schruppen Cutting data recommendations for indexable insert WPB-HF Roughing

	Werkstoff	Material	Werkstoff-Nr. Material No.	DIN Bezeichnung Alt DIN Description Old	R _m /UTS (N/mm ²)	DIN Bezeichnung Neu DIN Description New				
P	Unlegierter Baustahl + Automatenstahl	Plain carbon steel + free cutting steel	1.0570	St52-3	-700	S355J2G3				
			1.1730	C45	-800	C45U				
			1.0715	9SMn28	-700	11SMn30				
			1.1191 1.7219	Ck45 26CrMo4	500-950	C45E 26CrMo4-2				
	Vergütungsstahl, mittelfest	Heat-treatment steel, medium strength	1.7225 1.8159	42CrMo4 51CrV4	500-950	42CrMo4 51CrV4				
	Stahlguss	Cast steel	1.0416	GS40	-950	GS40				
	Einsatzstahl	Case hardening steel	1.7131	16MnCr5	-950	16MnCr5				
	Rost- und säure- beständiger Stahl, ferritisch, martensitisch	Stainless steel, ferritic, martensitic	1.4006	X10Cr13	500-950	X12Cr13				
			1.4104 1.4122	X12CrMoS17 X35CrMo17		X14CrMoS17 X39CrMo17-1				
	Vergütungsstahl, hochfest	Heat-treatment steel, high strength	1.7225 1.6580	42CrMo4 30CrNiMo8	950-1400	42CrMo4 30CrNiMo8				
	Nitrierstahl, vergütet	Nitriding steel, heat treated	1.8504	34CrAl6	950-1400	34CrAl6				
			1.2344	X40CrMoV5.1	-900	X40CrMoV5-1				
	Werkzeugstahl	Tool steel	1.2343	X38CrMoV5 1	950-1400	X37CrMoV5-1				
			1.2379	X155CrVMo12 1	-950	X153CrMoV12-1				
			1.2358	60CrMoV18-5	850-1000	60CrMoV18-5				
			1.2080	X210Cr12	950-1400	X210Cr12				
1.2714			55NiCrMoV7	1100-1350	55NiCrMoV7					
1.2311			40CrMnMo7	-1100	40CrMnMo7					
1.2312			40CrMnNiMoS8.6	-1150	40CrMnNiMoS8-6					
1.2316 1.2738			X38CrMo16 45CrMnNiMo8.6.4	-1100 950-1150	X38CrMo16 45CrMnNiMo8-6-4					
M	Rost- und säure- beständiger Stahl, austenitisch	Stainless steel, austenitic	1.4301	X2CrNiMo17-12-2	500-950	X5CrNiMo18-10				
			1.4404	X6CrNiMoTi17-12-2		X2CrNiMo17-12-2				
			1.4571	X10CrNiMoTi18		X10CrNiMoTi18				
Rost- und säure- beständiger Stahl, martensitisch aushärtbar	Stainless steel, martensitic steel	1.2709	X3NiCoMoTi18-9-5	800-1000	X3NiCoMoTi18-9-5					
		1.4542 1.4568	X5CrNiCuNb16-4 X7CrNiAl17-7		X5CrNiCuNb16-4 X7CrNiAl17-7					
K	Grauguss	Grey cast iron	0.6025	GG25	100-400 (120-260 HB)	EN-GJ1-250				
			Legierter Grauguss	Alloyed grey cast iron	0.6678	GGL-NiCr35 2	150-250 (160-230 HB)	EN-GJLA-XNiCr35-2		
					Sphäroguss	Nodular cast iron	0.7060	GGG60	400-800	EN-GJS-600-3
							0.7070	GGG70L	(120-310 HB)	EN-GJS-700-2U
Temperguss	Malleable cast iron	0.8155	GTS55	350-700 (150-280 HB)	EN-GJMB-550-4					
N	Aluminium-Legierungen, kurzspanend	Aluminium alloys, short chipping	3.2581	G-AlSi12	-400	G-IGK-AlSi12				
	Aluminium-Legierungen, langspanend	Aluminium alloys, long chipping	3.3535	AlMg3	-550	AlMg3				
	Kupfer-Legierungen, kurzspanend	Copper alloys, short chipping	2.0402	MS58	-500	AlZnMgCu1,5 CuZn40Pb2				
	Kupfer-Legierungen, langspanend	Copper alloys, long chipping	2.0320	MS63	300-500	CuZn37				
			2.0975	CuAl10Ni		CuAl10Fe5Ni5-C				
	Thermoplaste	Thermoplastics		PVC	40-70	PVC				
	Duroplaste	Duroplastics		Bakelit, Melamin	20-40	Bakelit, Melamin				
	Graphit	Graphite								
Zirkonoxidkeramik	Zircon oxide ceramics									
S	Titan-Legierungen, mittelfest	Titanium alloys, medium strength	3.7115 3.7164	TiAl5Sn2,5 TiAl6V4	-950	TiAl5Sn2-5 Ti6AlV4				
	Titan-Legierungen, hochfest	Titanium alloys, high strength	3.7174	TiAl6Sn2	900-1400	TiAl6V6Sn2				
	Nickelbasis-Legierungen, mittelfest	Nickel based alloys, medium strength	2.4670	NiCr12Al6MoNb	-950	NiCr12Al6MoNb				
	Nickelbasis-Legierungen, hochwarmfest	Heat resistant nickel based alloys, high strength	2.4668	NiCr19Fe19NbMo	900-1400	Inconel 718 NiCr19Fe19Nb5Mo3				
	Kobalt-Chrom-Legierung	Cobalt chromium alloys								
H	Hartguss	Chilled cast iron		Ni-hard, Ampco	300-600 HB	Ni-hard, Ampco				
	Gehärteter Stahl	Hardened steel			45-52 HRC					
					53-59 HRC					
					60-65 HRC					

Die angegebenen Schnittwerte sind Startwerte und müssen auf die vorhandenen Bedingungen abgestimmt werden.

Schnittgeschwindigkeit Cutting speed v_c (m/min)					Vorschub pro Zahn Feed per tooth f_z (mm/z.)								a_e Schruppen Roughing
					$\varnothing 6$	$\varnothing 8$	$\varnothing 10$	$\varnothing 12$	$\varnothing 16$	$\varnothing 20$	$\varnothing 25$	$\varnothing 32$	
LCPK30M	LCPK10M LCPK25M	LWNS10M	LWNS30M	a_p max f_z max	a_p max f_z max	a_p max f_z max	a_p max f_z max	a_p max f_z max	a_p max f_z max	a_p max f_z max	a_p max f_z max	a_p max f_z max	max. 70 %
180-200	180-200			0,30 0,30	0,40 0,40	0,50 0,50	0,60 0,60	0,80 0,80	1,00 1,20	1,20 1,50	1,50 1,50	d x 0,7	
180-200	180-200			0,30 0,30	0,40 0,40	0,50 0,50	0,60 0,60	0,80 0,80	1,00 1,20	1,20 1,50	1,50 1,50		
180-200	180-200			0,30 0,30	0,40 0,40	0,50 0,50	0,60 0,60	0,80 0,80	1,00 1,20	1,20 1,50	1,50 1,50		
180-200	180-200			0,30 0,30	0,40 0,40	0,50 0,50	0,60 0,60	0,80 0,80	1,00 1,20	1,20 1,50	1,50 1,50		
180-200	180-200			0,30 0,30	0,40 0,40	0,50 0,50	0,60 0,60	0,80 0,80	1,00 1,20	1,20 1,50	1,50 1,50		
180-200	180-200			0,40 0,30	0,60 0,30	0,80 0,40	0,80 0,50	1,00 0,60	1,00 0,80	1,30 1,00	1,50 1,25		
160-180	160-180			0,25 0,30	0,30 0,30	0,40 0,40	0,50 0,50	0,60 0,60	0,80 0,80	1,30 1,00	1,50 1,25		
140-160	140-160			0,25 0,30	0,30 0,30	0,40 0,40	0,50 0,50	0,60 0,60	0,80 0,80	1,30 1,00	1,50 1,25		
140-160	140-160			0,30 0,30	0,40 0,40	0,50 0,40	0,60 0,50	0,80 0,60	1,00 0,80	1,20 1,00	1,50 1,20		
180-200	180-200			0,30 0,30	0,40 0,40	0,50 0,50	0,60 0,60	0,80 0,80	1,00 1,20	1,20 1,50	1,50 1,50		
140-160	140-160			0,30 0,30	0,40 0,30	0,50 0,40	0,60 0,60	0,80 0,80	1,00 1,00	1,20 1,20	1,50 1,50	d x 0,7	
140-160	140-160			0,30 0,30	0,40 0,30	0,50 0,40	0,60 0,60	0,80 0,80	1,00 1,00	1,20 1,20	1,50 1,50		
180-200	180-200			0,30 0,30	0,40 0,30	0,50 0,40	0,60 0,50	0,80 0,60	1,00 0,80	1,20 1,00	1,50 1,25	d x 0,7	
180-200	180-200			0,40 0,30	0,60 0,30	0,80 0,40	0,80 0,50	1,00 0,60	1,00 0,80	1,30 1,00	1,50 1,25		
180-200	180-200			0,40 0,30	0,60 0,30	0,80 0,40	0,80 0,50	1,00 0,60	1,00 0,80	1,30 1,00	1,50 1,25		
180-200	180-200			0,40 0,30	0,60 0,30	0,80 0,40	0,80 0,50	1,00 0,60	1,00 0,80	1,30 1,00	1,50 1,25		
		400-500	400-500	0,40 0,30	0,60 0,30	0,80 0,40	0,80 0,50	1,00 0,60	1,00 0,80	1,30 1,00	1,50 1,25	d x 0,7	
		350-400	350-400	0,40 0,30	0,60 0,30	0,80 0,40	0,80 0,50	1,00 0,60	1,00 0,80	1,30 1,00	1,50 1,25		
		250-300	250-300	0,30 0,40	0,40 0,50	0,50 0,60	0,60 0,80	0,80 1,20	1,00 1,50	1,20 1,50	1,50 1,50		
		250-300	250-300	0,30 0,40	0,40 0,50	0,50 0,60	0,60 0,80	0,80 1,20	1,00 1,50	1,20 1,50	1,50 1,50		
		500-600	500-600	0,30 0,50	0,40 0,80	0,50 1,00	0,60 1,00	0,80 1,20	1,00 1,50	1,20 1,50	1,50 1,50		
80-100	80-100			0,20 0,25	0,30 0,30	0,40 0,35	0,40 0,40	0,50 0,50	0,50 0,60	0,60 0,80	0,80 1,00	d x 0,7	
60-80	60-80			0,20 0,25	0,30 0,30	0,40 0,35	0,40 0,40	0,50 0,50	0,50 0,60	0,60 0,80	0,80 1,00		
100-120	100-120			0,20 0,25	0,30 0,30	0,40 0,35	0,40 0,40	0,50 0,50	0,50 0,60	0,60 0,80	0,80 1,00		
80-100	80-100			0,20 0,25	0,30 0,30	0,40 0,35	0,40 0,40	0,50 0,50	0,50 0,60	0,60 0,80	0,80 1,00		
100-120	100-120			0,20 0,25	0,30 0,30	0,40 0,35	0,40 0,40	0,50 0,50	0,50 0,60	0,60 0,80	0,80 1,00	d x 0,7	
140-160	140-160			0,30 0,30	0,40 0,40	0,50 0,50	0,60 0,60	0,80 0,80	1,00 1,20	1,20 1,50	1,50 1,50		
80-100	80-100			0,20 0,25	0,30 0,30	0,40 0,35	0,40 0,40	0,50 0,50	0,50 0,60	0,60 0,80	0,80 1,00		

The cutting data indicated are starting values and must be adjusted to the prevailing conditions.

Schneidstoffe Cutting material grades	Beschreibung	Description
LCHK20M	HC-K20 PVD-TiAlN/AlCrN beschichtet Spezielle Feinstkorn-Hartmetallsorte besonders geeignet für die Hartbearbeitung bis 65 HRC. Ebenfalls auch gut in der Gussbearbeitung einsetzbar	HC-K20 PVD TiAlN/AlCrN coated Special fine grain carbide grade especially for hard machining up to 65 HRC. Also suitable for machining cast iron
LCHP15M	HC-K15 – PVD TiSiN beschichtet Spezielle Feinstkorn-Hartmetallsorte besonders geeignet für die Hartbearbeitung bis 65 HRC. Ebenfalls gut für die Stahlbearbeitung geeignet	HC-K15 – PVD TiSiN coated Special fine grain solid carbide grade especially for hard machining up to 65 HRC. Also suitable for machining steel.
LCK10M	Schneidstoffsorte speziell für die Gussfräsbearbeitung Feinstkorn Hartmetall beschichtet mit der TERAspeed (AlTiN) für die Hochleistungsgussbearbeitung, für hohe Schnittgeschwindigkeiten und für Trockenbearbeitung geeignet	Cutting material grades specifically for cast iron milling Finest grade carbide coated with TERAspeed (AlTiN) for high-performance cast iron machining, high cutting speeds and dry machining
LCKP10M	HC-K10 PVD-TiAlN beschichtet Hochverschleißfeste beschichtete Fräsorte mit hoher Schneidkantenstabilität zur Feinbearbeitung von legierten und unlegierten Werkzeugstählen, hochfesten Werkstoffen, NE-Metallen und Grauguss mit höheren Schnittgeschwindigkeiten. ■ Kleine bis mittlere Spannungstiefen ■ Kleine bis mittlere Zahnvorschübe	HC-K10 PVD TiAlN coated Highly wear-resistant coated milling grade with high cutting edge stability for fine machining of alloyed and unalloyed tool steels, high-strength materials, non-ferrous metals and cast iron at high cutting speeds. ■ Low to medium depths of cut ■ Low to medium chip load
LCM45M	HC-P40 – PVD AlTiN Feinstkornsubstrat mit einem hohen Kobaltgehalt und einer extrem feinkörnige nanokristalline AlTiN Schicht. Die Kombination daraus ermöglicht eine hohe Wirtschaftlichkeit beim Trocken- und Nassfräsen von rostfreien und rostbeständigen Stählen, bei niedrigen bis mittleren Schnittgeschwindigkeiten.	HC-P40 – PVD AlTiN Ultra-fine grain substrate with high cobalt content combined with a nanocrystalline AlTiN coating. The new grade offers economic efficiency of dry and wet milling of stainless and corrosion-resistant steel grades at low to medium cutting speeds.
LCMS30M	HC-K30 – PVD TiAlN/AlCrN Dieser neue Schneidstoff mit mehrlagiger feinkristalliner PVD Hochleistungsbeschichtung der aktuellen Generation kombiniert die Eigenschaften höchster Ansprüche gegenüber Verschleißreduzierung bei gleichzeitig hoher Temperaturbeständigkeit beim Fräsen in hochwarmfesten Materialien	HC-K30 – PVD TiAlN/AlCrN New generation multilayer finegrain coating which combines best wear resistance as well as high temperature resistance when machining hot working steels.
LCMS34M	Spezielle Sorte für die Bearbeitung von rostfreien-, hochwarmfesten Stählen und Titan, geeignet für mittlere Schruppoperationen und zum Schlichten.	Special grade for processing stainless, highly heatresistant steels and titanium, suitable for medium roughing operations and for finishing.
LCP40M	HC-P40 PVD-AlCrN beschichtet Hochverschleißfeste Sorte mit hoher Zähigkeit zum Nass- und speziell zum Trockenfräsen von Stahl, Stahlguss und Grauguss. ■ Mittlere bis hohe Schnittgeschwindigkeit ■ Mittlere bis hohe Spanungsquerschnitte ■ Mittlere bis hohe Zahnvorschübe	HC-P40 – PVD-AlCrN coated Highly wear-resistant grade with high toughness for wet milling and dry milling, in particular, steel, cast steel and cast iron. ■ Medium to high cutting speeds ■ Medium to high chip-forming cross sections ■ Medium to high chip load
LCPK10M	HC-K10 PVD- AlCrN beschichtet Hochverschleißfeste beschichtete Fräsorte mit hoher Schneidkantenstabilität zur Feinbearbeitung von legierten und unlegierten Werkzeugstählen. Hohe Stabilität und Verschleißfestigkeit gerade bei extrem hoher Temperaturbelastung. Geeignet für die Trocken- und HSC-Bearbeitung bis 54 HRC. ■ Kleine bis mittlere Spannungstiefen ■ Kleine bis mittlere Zahnvorschübe	HC-K10 PVD- AlCrN coated Highly wear-resistant coated milling grade with high cutting edge stability for fine machining alloyed and unalloyed tool steels. High stability and wear-resistance specifically by high temperatures. Suitable for dry machining and high speed cutting up to 54 HRC. ■ Low to medium depths of cut ■ Low to medium chip load

Schneidstoffe Cutting material grades	Beschreibung	Description
LCPK25M	HC-K20/K30 Nanomold Black (TiAlN basiert) Verschleißfeste und zugleich zähe, beschichtete Fräsorte mit einer hohen Schneidkantenstabilität, dadurch besonders geeignet für das Schruppen und Semi-Schlichten von legierten und unlegierten Werkzeugstählen, hochfesten Werkstoffen, Gusseisen. Geeignet für die Trocken-, Nass-, sowie MMS-Zerspanung.	HC-K20/K30 Nanomold Black (TiAlN based) Highly wear resistant and tough, coated milling grade with high cutting edge stability and thus particularly suitable for roughing and semi-finishing alloyed and unalloyed tool steels, high-strength materials and cast iron. Suitable for dry, wet and MQL machining.
LCPK30M	HC-K30 Nanomold Gold Hochverschleißfeste Fräsorte mit einer hohen Schneidkantenstabilität. Eignung für das Schruppen und Semi-Schlichten von legierten und unlegierten Werkzeugstählen, hochfesten Werkstoffen und Gusseisen. Besondere Eignung für die Trockenzerspanung.	HC-K30 Nanomold Gold Wear-resistant milling grade with maximum cutting edge stability. Suitable for roughing and semi-finishing of alloyed and non-alloyed tool steel, high-strength materials, and cast iron. Ideal for dry machining.
LCPK40M	HC-K40 – PVD AlTiN/AlCrN beschichtet Verschleißfeste Feinkornsorte mit hohen Zähigkeits-eigenschaften speziell für das Hochvorschubfräsen von Vergütungs- und Werkzeugstählen mit sehr hohen Zahnvorschüben geeignet.	HC-K40 – PVD AlTiN/AlCrN coated Wear-resistant fine grain grade with high ductile values especially suited for high feed milling with very high feed per tooth in heat treatment steels and tool steels.
LCPM40M (LC280QN)	Eine Kombination von besonders zähem Hartmetall-substrat mit einer 2-fach PVD-Beschichtung kennzeichnet bereits optisch die hervorragende Eignung dieser Wendeschneidplatten zum Schruppen. Die Wendeschneidplatten sind vollständig mit AL6 beschichtet und besitzen zusätzlich am Umfang eine TiN-Schicht zur besseren Verschleißerkennung	A combination of tough carbide substrate with a double PVD coating makes it obvious that these indexable inserts are ideal for roughing. The inserts are completely coated with AL6 and have an additional TiN-layer at circumference which allows to observe wear easier.
LWNS10M	HW-K10 Feinkorn unbeschichtet Hochverschleißfeste Fräsorte zur Bearbeitung von Grauguss, Al-Legierung und Nichteisenmetallen mit mittlerer bis höheren Schnittgeschwindigkeiten auch unter ungünstigen Betriebsbedingungen.	HW-K10 micro-grain uncoated Milling grade with high wear resistance for machining of grey cast iron, aluminium alloys, and non-ferrous metals at medium to higher cutting speeds, even under unfavourable machining conditions.
LWNS30M	HC-K30 unbeschichtet Hochverschleißfeste Fräsorte mit hoher Schneidkantenstabilität zur Bearbeitung von Al-Legierungen, Titan und Nichteisenmetalle mit hohen Schnittgeschwindigkeiten. <ul style="list-style-type: none"> ■ Mittlere Spannungstiefen ■ Mittlere Zahnvorschübe 	HC-K30 uncoated Milling grade with high wear resistance and high cutting edge stability for machining of aluminium alloys, titanium and non-ferrous metals with high cutting speeds. <ul style="list-style-type: none"> ■ Medium depths of cut ■ Medium chip load

Impressum

Herausgeber: LMT Tool Systems GmbH & Co. KG,
Grabauer Strasse 24, 21493 Schwarzenbek, Deutschland, Telefon: +49 41 51 12-0
Verantwortlich i. S. d. P.: Norman Winter
Gestaltung: deckermedia GbR, Rostock
Druck: Weidner GmbH, Rostock

Publication details

Publisher: LMT Tool Systems GmbH & Co. KG,
Grabauer Strasse 24, 21493 Schwarzenbek, Germany, Phone: +49 41 51 12-0
Responsible according to the press law.: Norman Winter
Design: deckermedia GbR, Rostock
Printed by: Weidner GmbH, Rostock

© by LMT Tool Systems GmbH & Co. KG
Nachdruck, auch auszugsweise, ist nur mit unserer Zustimmung gestattet.
Alle Rechte vorbehalten. Irrtümer, Satz- oder Druckfehler berechtigen nicht zu irgendwelchen Ansprüchen. Abbildungen, Ausführungen und Maße entsprechen dem neuesten Stand bei Herausgabe dieser Druckschrift. Technische Änderungen müssen vorbehalten sein. Die bildliche Darstellung der Produkte muss nicht in jedem Falle und in allen Einzelheiten dem tatsächlichen Aussehen entsprechen.
Bildquellen: Studio Thomas Schmitz, Hamburg

This publication may not be reprinted in whole or part without our express permission. All rights reserved. No rights may be derived from any errors in content or from typographical or typesetting errors. Diagrams, features and dimensions represent the current status on the date of issue of this catalog. We reserve the right to make technical changes. The visual appearance of the products may not necessarily correspond to the actual appearance in all cases or in every detail.
Sources: Studio Thomas Schmitz, Hamburg





Wir sind weltweit für Sie da!
Nehmen Sie Kontakt zu uns und unseren Experten auf: www.lmt-tools.com

We are committed to you worldwide!
Contact us and our experts: www.lmt-tools.com